

WIDEPIX[®]
2(1)X5 - MPX3

Large area imaging detector

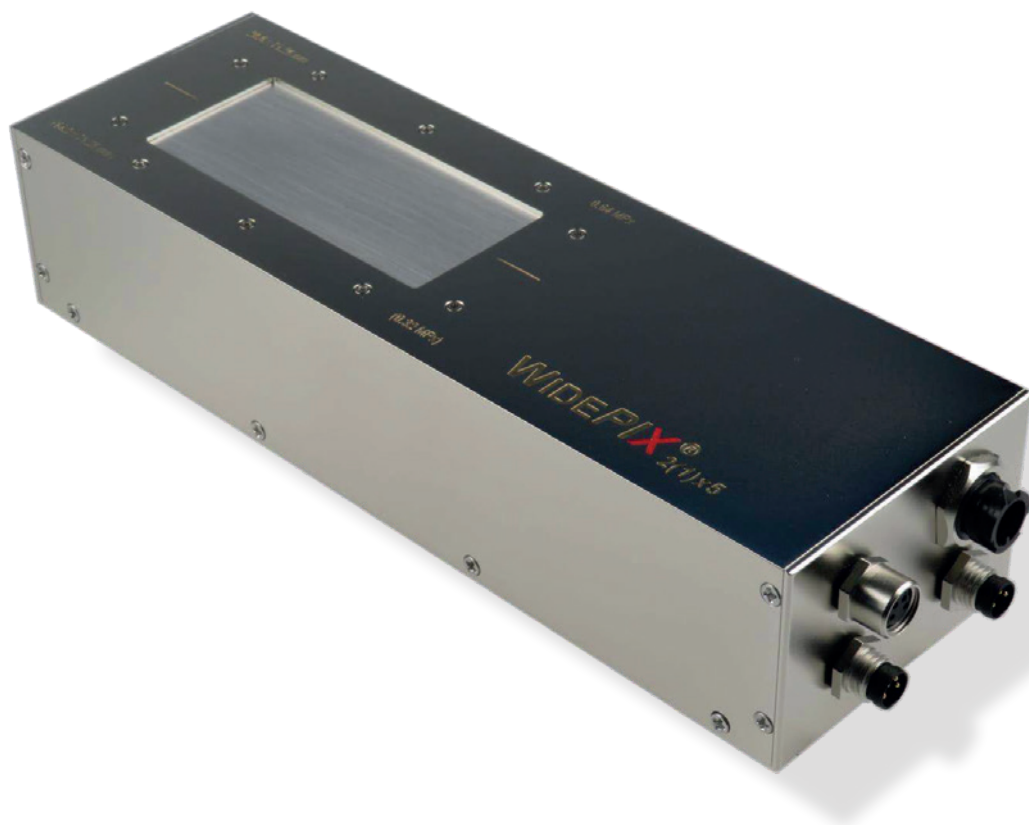

Large area imaging detector

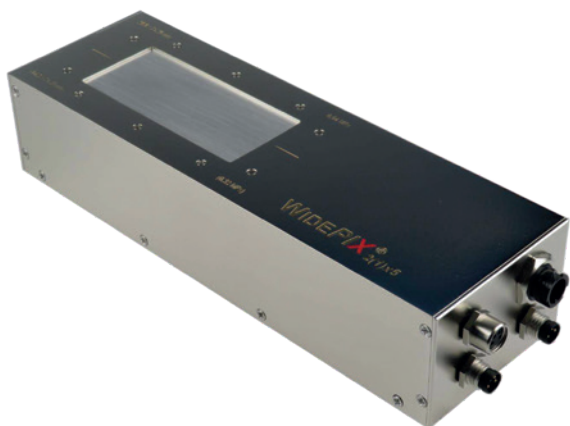

The large area imaging detector WIDEPIX_{2(1)X5 - MPX3} with resolution of 512 (256) x 1280 pixels i.e. 0.64 (0.32) Mpixels is composed of Medipix3 hybrid detector electronics tiles. Each tile (256 x 256 pixels) is attached to an edgeless silicon or CdTe sensor. Therefore, the whole area of the WIDEPIX_{2(1)X5 - MPX3} device is fully sensitive and there are no gaps between sensor tiles. Each pixel has two integrated 12-bit digital counters and two energy discrimination thresholds. The counters store number of registered particles, e.g. X-ray photons, with energy above the appropriate threshold. Both counters can be joined to a single 24-bit counter providing enhanced dynamic range.

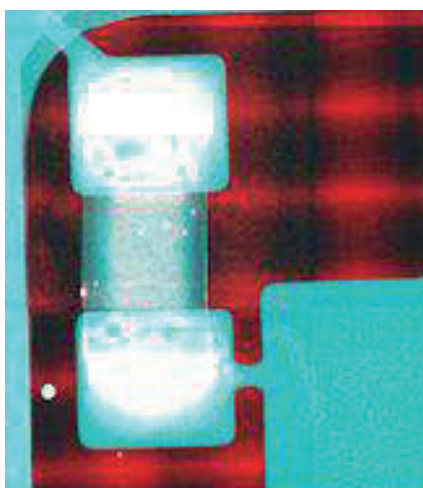

Illustration of multichannel "color" radiographs, where different materials are identified and imaged in different colors

Key features	
Readout chip type	Medipix3
Pixel size	55 x 55 µm
Sensor resolution	512 (256) x 1280 pixels
Dynamic range in one frame	12-bit / 24-bit ¹
Dark current	none
Interface	USB 2.0 (Full-Speed)
Maximum frame rate	20 (50) fps
Dimensions	213 x 60 x 40 mm
Weight	1800 g
¹ Depends on operation mode. Higher dynamic range can be achieved by summing multiple images.	

The particle counting principle eliminates any additional noise generated by the sensor or electronic readout. It allows acquiring X-ray images with very high contrast and wide dynamic range. Therefore, even low contrast structures such as plastic or soft tissue are easily detectable in X-ray images.

Both devices are suitable for CT scanners, which can take advantage of large sensitive area without any gaps. The WIDEPIX_{1X5 - MPX3} variant moreover supports a hardware-based Time-Delayed-Integration mode for online (continuous) scanning applications.

The energy discrimination thresholds of Medipix3 technology allow spectral X-ray imaging. Different materials in an inspected sample could be then identified based on their spectral X-ray attenuation properties. Energy spectra could be measured typically from 5 keV upwards.

The Charge Summing Mode implemented in the pixel electronics provides hardware-based correction of signal cross talk between pixels. This further considerably improves the detector spectral response and therefore also quality of spectra measured in individual pixels.

The camera is connected to a computer via USB 2.0 cable. The readout time is 50 (25) ms per frame resulting in maximum frame rate of 20 (50) frames per second.

Large area imaging detector

Device parameters

Operating conditions						
Symbol	Parameter	Min	Typ	Max	Units	Comment
T_A	Temperature Range	0	30	40	°C	
Φ	Humidity		55	60	%	Not condensing
	IP Code		IP50			

Family parameters

$T_A = 25\text{ °C}$, $V_{CC} = 24\text{ V}$

Symbol	Parameter	WidePIX 1x5 - MPX3	WidePIX 2x5 - MPX3	Units	Comment
V_{CC}	Supply Voltage	20/24/26		V	Min/Typ/Max
I_{CC}	Supply Current ($V_{CC} = 24\text{ V}$)	340/680	800/1600	mA	Typ/Max
P	Power dissipation	9/18	16/36	W	Typ/Max
A	Sensor Area	71.5 x 14.1	71.1 x 28.2	mm	
	Detector Resolution	256 x 1280	512 x 1280	Pixels	
f	Frame Rate ¹	50	20	fps	
T_{READ}	Readout Time ²	20	50	ms	
m	Weight	1700	1800	g	

¹ Operating parameters: Shutter time = 1 ms, Mode = CSM or SPM-1Ch 12 bit resolution.

² During Readout Time (or dead time), no charge is collected from the sensor.

Modes of readout chip operation

Type	Mode	Bit depth	Description
Frame (reading all pixels)	SPM-1Ch	12/24 bit/frame	Single Pixel Mode using one counter: Every pixel works independently of its neighbors. One energy threshold (energy channel) is available. 1 output image: Number of events per pixel
	SPM-2Ch	12 bit/frame	Single Pixel Mode using both counters: Every pixel works independently of its neighbors. Two energy thresholds (energy channels) are available. 2 output images: Number of events per pixel
	CSM	12/24 bit/frame	Charge Summing Mode: The charge from 4 adjacent pixels is summed and is assigned to the pixel with the largest charge deposition. The event is counted only if the sum of signals exceeds the energy threshold. 1 output image: Number of events per pixel

All modes can be operated at three ranges: Broad / Narrow / Super Narrow (Except CSM mode Silicon sensor.)

Large area imaging detector

Energy range and resolution

Typical values for 300 µm Silicon sensor, T _A = 20 °C.						
Range	Mode	Min Energy [keV]	Max Energy [keV]	Resolution* @Cu-Kα (cca 8 keV)	Resolution* @Zr-Kα (cca 15 keV)	Resolution* @Pb-Kα (cca 75 keV)
Super Narrow	SPM	2.5 - 4.0	100 - 110	0.7 - 1.5		3.5 - 7.0
Narrow	SPM	2.5 - 4.0	160 - 180	0.8 - 1.3	-	3.0 - 3.8
	CSM	6.0	-	1.5	1.5	12.0
Broad	SPM	5.0 - 6.5	260 - 290	1.6 - 2.0	-	3.3 - 4.0
	CSM	8.0	-	-	2.3	5.8

* Resolution in Sigma of gaussian fit.

Typical values for 1000 µm CdTe sensor, T _A = 20 °C.						
Range	Mode	Min Energy [keV]	Max Energy [keV]	Resolution* @Cu-Kα (cca 8 keV)	Resolution* @Zr-Kα (cca 15 keV)	Resolution* @Pb-Kα (cca 75 keV)
Super Narrow	SPM	5.0 - 10				
	CSM	10 - 20				
Narrow	SPM	5.0 - 10				
	CSM	10 - 20				
Broad	SPM	5.0 - 10				
	CSM	10 - 20				

* Resolution in Sigma of gaussian fit.

Sensor parameters

Symbol	Parameter	Sensor material			Units	Comment
		Si	CdTe			
	Thickness	300	1000	1000	µm	
V _{bias}	Bias Voltage	200	500	-450	V	Max
	Typical detectable energy range for X-rays*	up to 60	up to 600	keV	See chart	
	Pixel size	55 x 55**		µm ²		

* to get true detector response, detectable energy and quantum efficiency of sensor chip has to be combined with energy range of readout chip (see chapter "Energy range and resolution")

** Pixels on tile borders are 2.5 times larger in one direction. The corner tile pixels are 2.5 times larger in both directions.

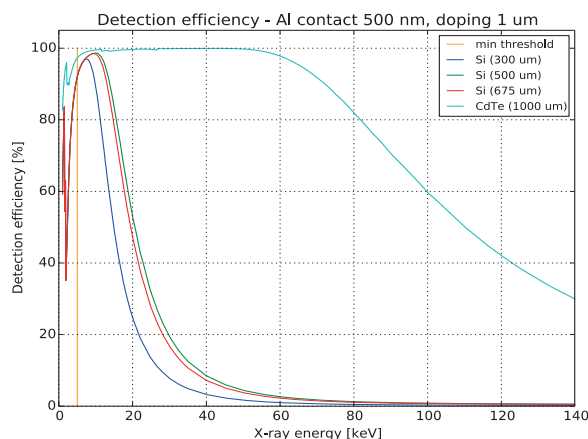

Large area imaging detector

Device description

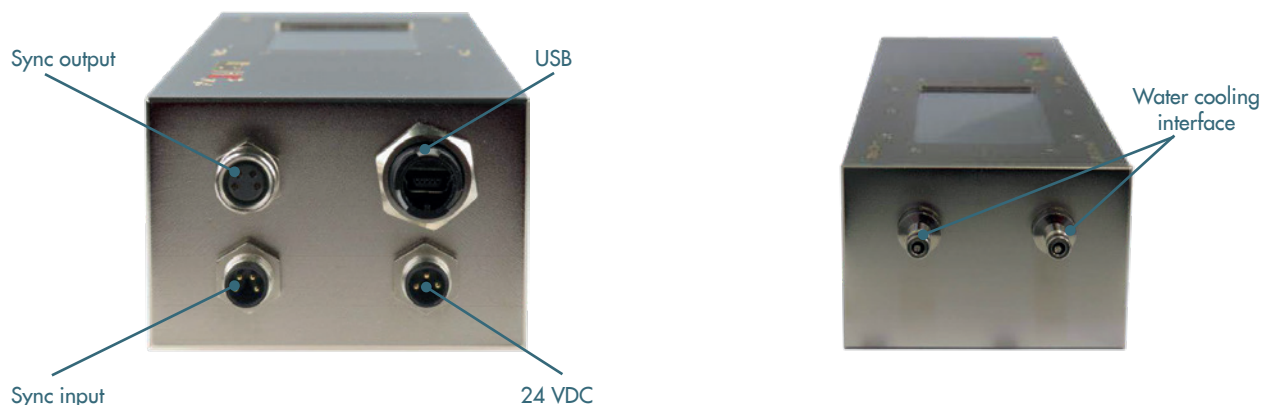

USB connector

USB type A, Standard USB 2.0 Full-Speed, in IP68 protection.

+24VDC connector

Main power supply (via standard M8 connector with 3 female contacts) Connect after plugging USB connector.

Synchronization interface

Two 4-pin M8 connectors (female for outputs and male for input) serve as synchronization interface, allowing to synchronize WIDEPIX_{2(1)X5 - MPX3} detector with external processes. Four signals are available:

- Ready in – measurement is not possible, when signal at logical zero
- Trigger in – logical zero starts shutter (measurement)
- Ready out – logical one if device is ready to for new shutter
- Trigger out – mirrors shutter (logical zero when shutter is active)

All signals are TTL compatible and 5V tolerant. For detailed description see Synchronization Guide.

Sync. Outputs (M8-4Female)		Sync. Inputs (M8-4Male)	
Pin	Signal	Pin	Signal
1	Gnd	1	Gnd
2	Ready Out	2	Trigger In
3	Trigger Out	3	Ready In
4	Reserved	4	Reserved

Water cooling interface

It is mandatory to cool down detector when in operation. WIDEPIX_{2(1)X5 - MPX3} uses water connectors that allow for quick disconnection/reconnection. Mating connector is included as standard accessories and has to be attached to 4x6 mm plastic hose.

Large area imaging detector

Mechanical dimensions

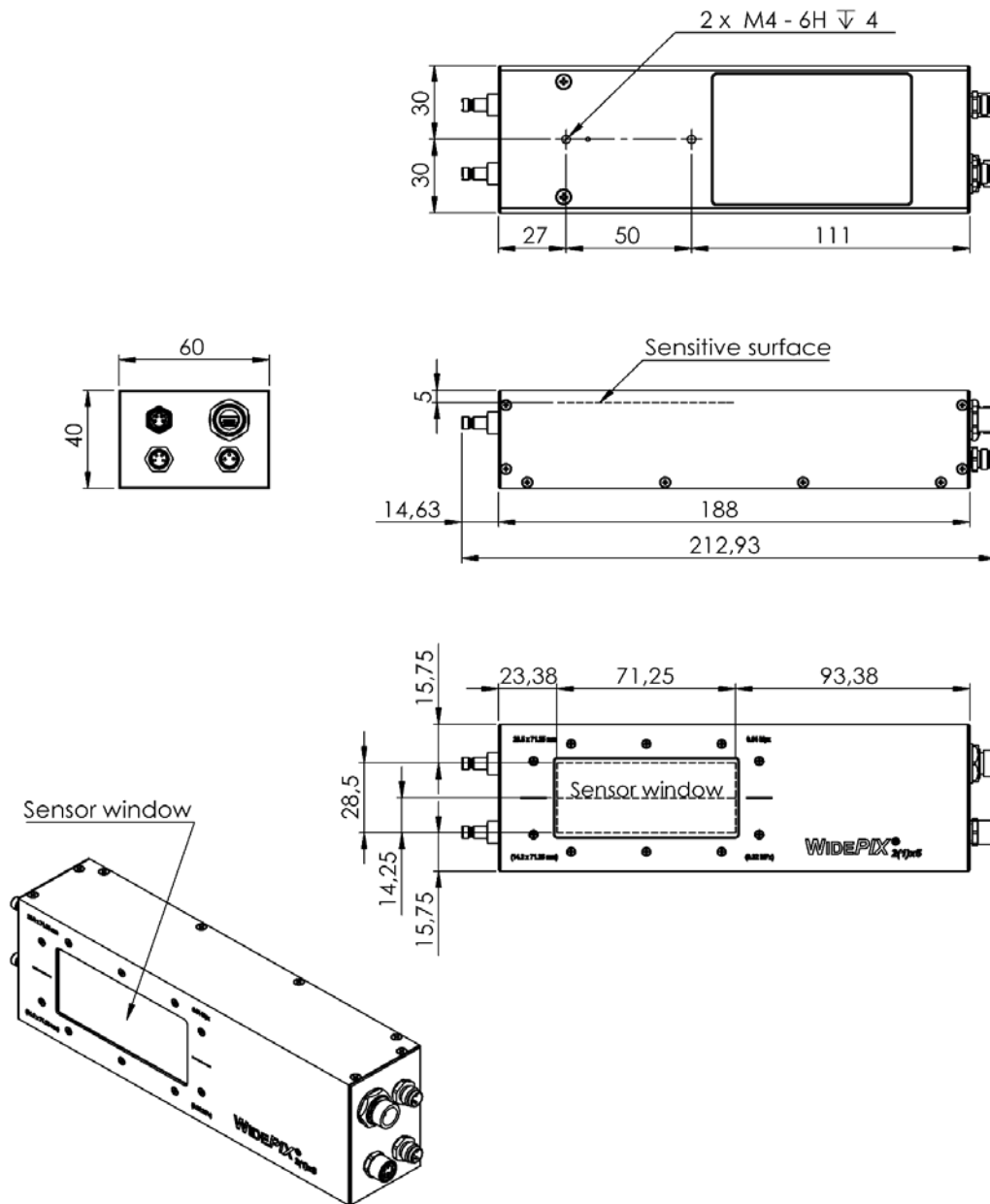

All dimensions are in mm.

* Sensitive surface distance from top of the box may vary depending on actual sensor thickness.

WIDEPIX[®]_{2(1)X5 - MPX3}

Large area imaging detector

Sensitive area

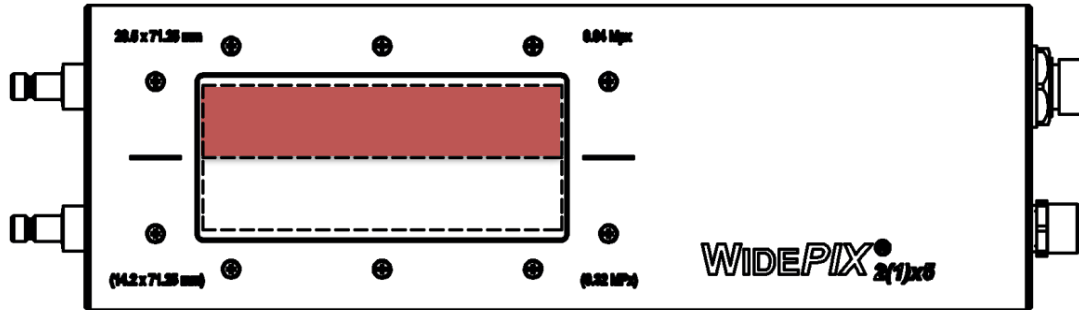

Sensitive area for WIDEPIX_{1x5 - MPX3}

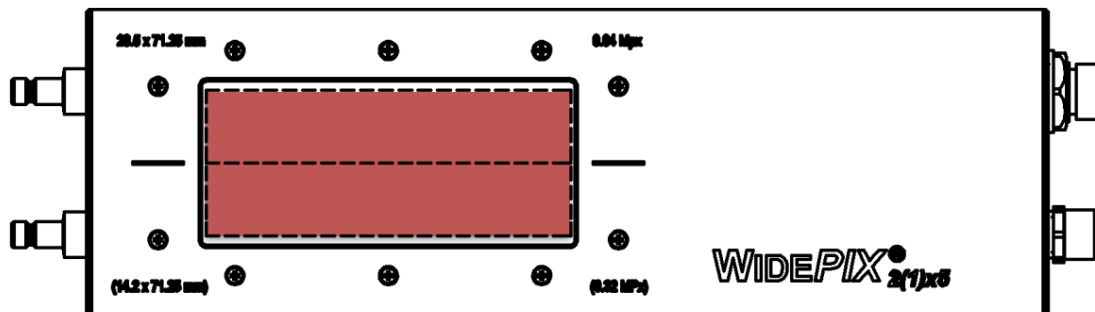

Sensitive area for WIDEPIX_{2x5 - MPX3}

Large area imaging detector

Instructions for safe use

To avoid malfunction or damage to your WIDEPIX_{2(1)x5-MPX3} please obey the following:

- Do not expose to water or moisture, WIDEPIX_{2(1)x5-MPX3} is dust protected only.
- Do not open WIDEPIX_{2(1)x5-MPX3} case. Detector wire-bonding connections may be irreversibly damaged.
- Do not operate detector when not properly water cooled. Otherwise detector temperature may rise above the specified range.

Do not touch sensor surface!



Product/Model number codes			
W251M3-XE3170307	1 row	Si edgeless sensor	thickness 300 µm
W251M3-XEA170307	1 row	Si edgeless sensor	thickness 1000 µm
W251M3-XCA170307	1 row	CdTe sensor	thickness 1000 µm
W252M3-XE3170307	2 rows	Si edgeless sensor	thickness 300 µm
W252M3-XEA170307	2 rows	Si edgeless sensor	thickness 1000 µm
W252M3-XCA170307	2 rows	CdTe sensor	thickness 1000 µm

Model number codes (example)

W25	2M3	X	C	A	170307
Device name W25 – WidePIX 1(2)x5	Device modification 1M3 – 1x5 Medipix3 chips 2M3 – 2x5 Medipix3 chips		Sensor type E – Edgeless silicon C – CdTe	Sensor thickness 3 – 300 µm 5 – 500 µm A – 1000	YY MM DD YY MM DD

Release history

Date	Changes
14/06/18	Preliminary version
15/10/18	