

Life Sciences Atomic Force Microscope

Model ID: ■ LS-AFM-A ■ LS-AFM-B

The **LS-AFM** is a tip-scanning AFM designed specifically for life science applications when paired with an inverted optical microscope. The product includes everything required for AFM scanning: AFM Stage, Inverted Microscope Adaptation Plate, Ebox, Manuals, Cables, and AFM-Control Software.

The LS-AFM may be purchased in two different configurations.

LS-AFM-A

For customers who own an inverted optical microscope: In this configuration, AFMWorkshop fabricates a special plate that pairs the LS-AFM with the customer's existing inverted optical microscope.

LS-AFM-B

This configuration includes the LS-AFM and a full-featured inverted optical microscope.



Features of the LS-AFM include:

- » Dry and Liquid Z Scanner
- » AFM Adapter Plate for Inverted Microscopes
- » Linearized XY Scanner
- » Advanced Force Distance Curves
- » Glass Slide and Petri Dish Sample Holder
- » Precision AFM Alignment System with Lock-Down
- » Included Modes: Vibrating, Non-Vibrating, Phase and LFM
- » Direct Drive Z Motor
- » Compatible With Standard AFM probes
- » Intuitive LabVIEW™ Software Interface
- » High Resolution Zoom Video Camera
- » High Resolution 24 Bit Scanning
- » USB Ebox Interface
- » Available With AFMWorkshop Inverted Microscope

APPLICATIONS

The **LS-AFM** is designed for the most widely used types of measurements made with an AFM, including measuring F/D curves and imaging cells in a dry and liquid environment.

► Cell Imaging

Images of cells are readily scanned in both a liquid and dry environment with the LS-AFM.



Image of an E Coli cell measured with the Dunk and Scan probe holder.

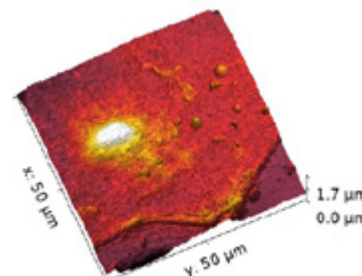
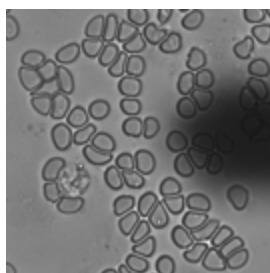

Image of cheek cell measured in ambient air.

► Imaging Cells In Combination With An Inverted Optical Microscope

The inverted optical microscope facilitates direct placement of the probe on an area of interest for scanning. Additionally the inverted microscope can be operated in epifluorescence mode.

Neutrophil A Cells



Inverted optical microscope image of neutrophil A cells.

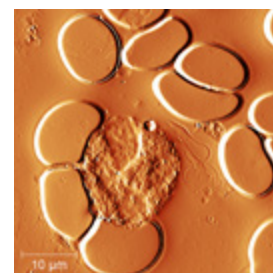

Light Shaded AFM image of the cells visualized in the optical microscope image.

CACO-2

CACO-2 cell structure in the presence of low concentration of quantum dots.

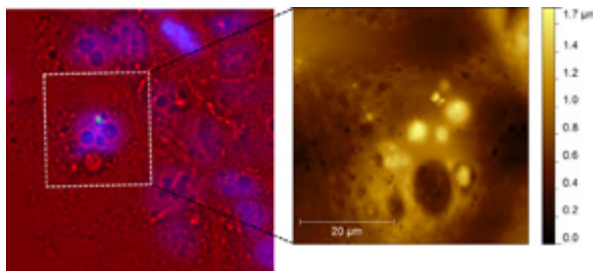

Left: Epifluorescence, showing brightfield (red), DAPI (blue), 2.2nm quantum dot PL emission at 560nm (green).

Right: Topographic AFM image of the indicated area.

Monitoring the deflection of a cantilever as it is pushed against a sample results in a force/distance curve. From the force distance curve many parameters may be measured, such as stiffness of the sample and probe-sample adhesion. In biological samples, the most common application is measurement of intermolecular forces. For example, this could be used to measure the interaction force between an antigen and an antibody directly. Cell-cell adhesion forces and cellular stiffness can also be measured.

► **F/D Curves**

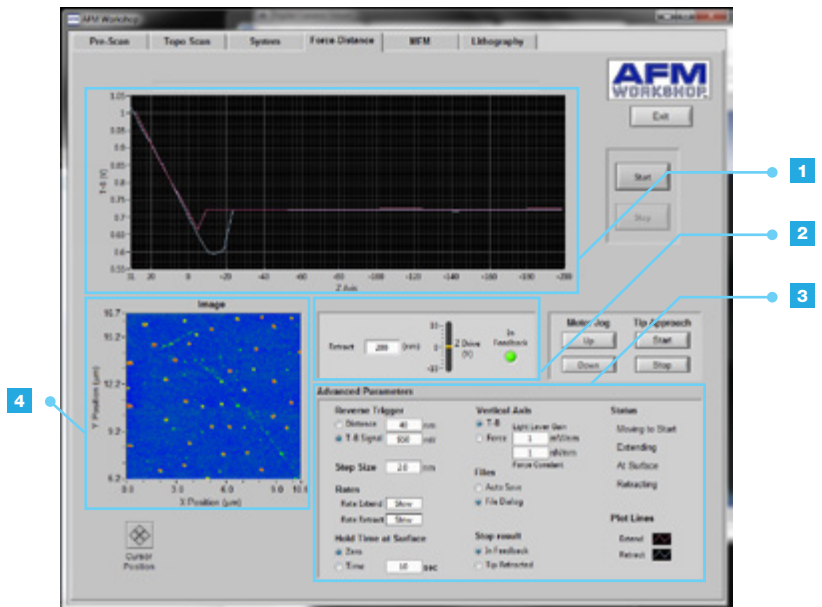

The above screen shot demonstrates Advanced Force Distance Curve software measuring an AFM image.

1. Force-Distance data display region
2. Slider indicates the extension of the Z piezoelectric ceramic
3. Control parameter selection options
4. AFM Image for selecting locations for force-distance measurements

The Force/Distance Curve Measurement Software Interface includes all the features required for making advanced measurements. F/D curves may be made on single or multiple points of a sample surface. Control parameters include extend/contract rate, turn around trigger, and number of measurements per selected region.

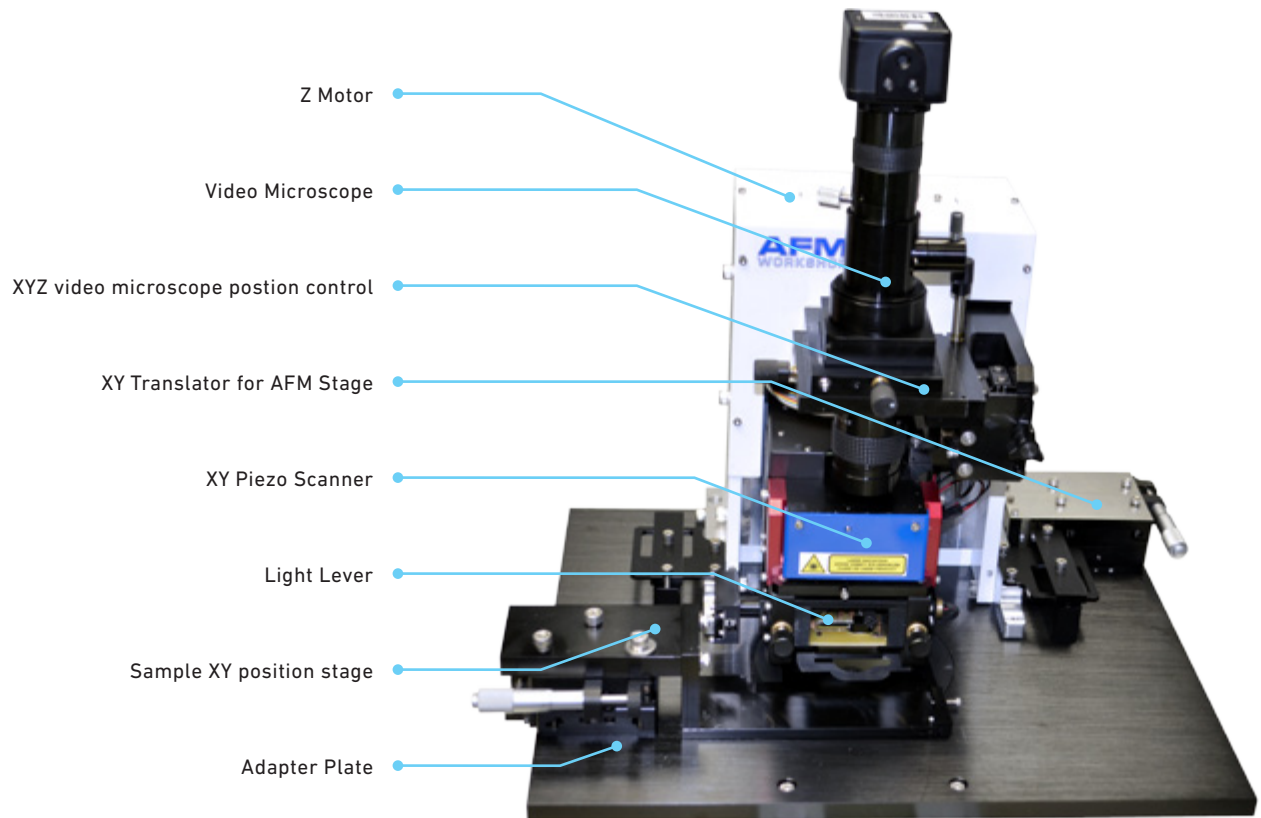

AFM STAGE

The AFM Stage is secured on an adapter plate that is attached to the inverted optical microscope.

There is an XY translation stage for moving the sample under the AFM Probe. Additionally there is an XY translation stage for moving the AFM over the inverted optical microscope axis.

► Sample Stage for the LS-AFM

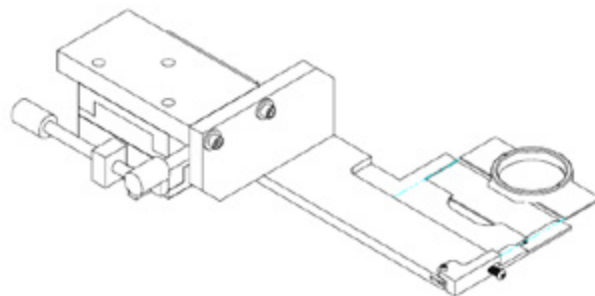

► Z Scanner for Liquid Imaging

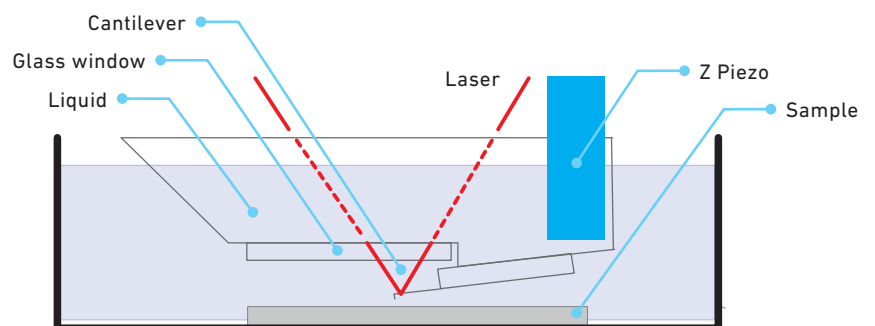

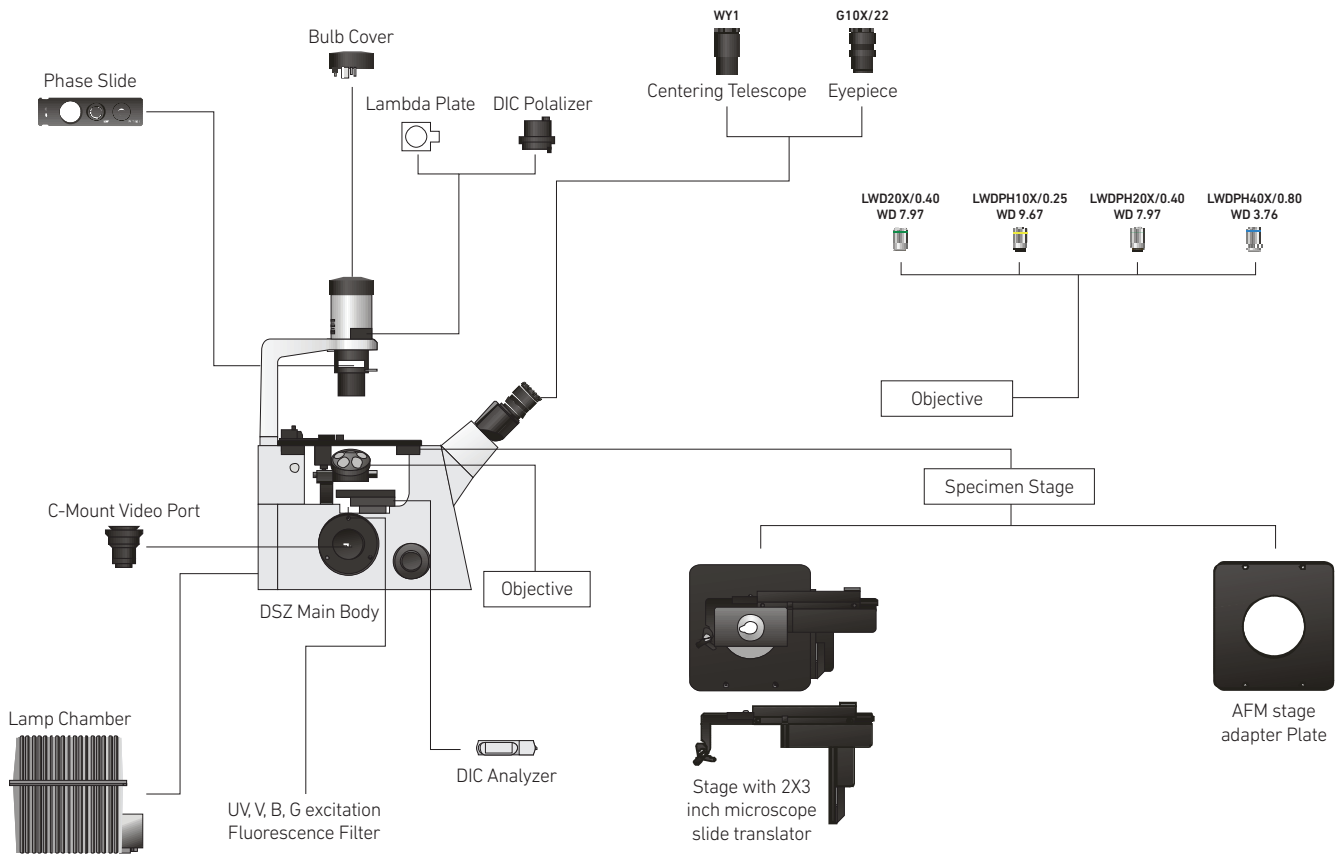

INVERTED MICROSCOPE (LS-AFM-B ONLY)

The **LS-AFM** may be purchased as an integrated AFM/Inverted Microscope. The Inverted Microscope includes all the options for Fluorescence, Phase Contrast, and standard Illumination imaging.

► Included Items

- a. Lamp Chamber for Fluorescence Microscopy
- b. UV, V, B, G excitation Filters
- c. Stage with 2" X 3" microscope slide translator
- d. AFM Stage Adapter Plate(supplied by AFMWorkshop)
- e. Objectives
 - » Infinity LWD plan achromatic objective 10x/0.25 WD9.67
 - » Infinity LWD plan achromatic objective 20x/0.40 WD7.97,
 - » Infinity LWD plan achromatic objective 40x/0.60 WD3.76
 - » Infinity LWD plan phase contrast objective 20x/0.40 WD7.97
- f. Centering Telescope
- g. DIC Polarizer
- h. Lambda Plate
- i. Bulb Cover
- j. Phase Slide
- k. C- mount port
- l. Main Body

► Not Shown

- » Power supply for fluorescence lamp
- » Power supply for illumination lamp
- » Video Camera

EBOX

Electronics in the LS-AFM are constructed around industry-standard USB data acquisition electronics. The critical functions, such as XY scanning, are optimized with a 24-bit digital to analog converter. With the analog Z feedback loop, the highest fidelity scanning is possible. Vibrating mode scanning is possible with both phase and amplitude feedback using the high sensitivity phase detection electronics.



▶ 24-bit scan DAC

Scanning waveforms for generating precision motion in the XY axis with the piezo scanners are created with 24-bit DACS driven by a 32-bit micro controller. With 24-bit scanning, the highest resolution AFM images may be measured. Feedback control using the XY strain gauges assures accurate tracking of the probe over the surface.

▶ Phase and Amplitude Detector Circuit

Phase and amplitude in the Ebox are measured with highly stable phase and amplitude chips. The system can be configured to feed back on either phase or amplitude when scanning in vibrating mode.

▶ Signal Accessible

At the rear of the Ebox is a 50 pin ribbon cable that gives access to all of the primary electronic signals without having to open the Ebox.

▶ Precision Analog Feedback

Feedback from the light lever force sensor to the Z piezoceramic is made using a precision analog feedback circuit. The position of the probe may be fixed in the vertical direction with a sample-and-hold circuit.

▶ Variable Gain High Voltage Piezo Drivers

An improved signal to noise ratio, as well as extremely small scan ranges are possible with the variable gain high voltage piezo drivers.

- Microprocessor for scan generation through 24-bit DAC's
- Low noise, variable gain high voltage amplifiers with PID feedback for XY scanning
- Dimensions: Width 6" | Height 10" | Depth 14"
- High fidelity, low noise Z feedback circuits for accurate probe tracking
- Phase and amplitude detection circuits for vibrating mode AFM
- Industry-standard National Instruments USB data acquisition board
- Internally accessible header for signal input/output
- Eight channels of ADC for monitoring and displaying data with LabVIEW™ software

SOFTWARE

Software for acquiring images is designed with the industry-standard LabVIEW™ programming visual interface instrument design environment.

Functions such as setting scanning parameters, probe approach, frequency tuning and real time image display are all standard, and included with the product.

If special enhancements are needed, LabVIEW™'s programming environment facilitates rapid software development. LabVIEW™ standards ensure that the LS-AFM can be combined with any other instrument using LabVIEW™ VI.

► Pre-scan Window

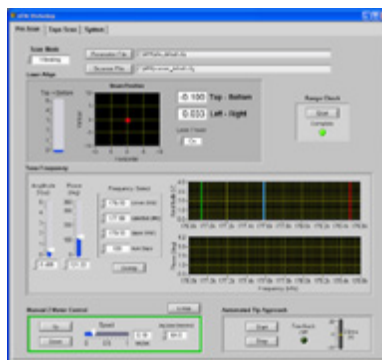

A pre-scan window presents users with a logical sequence of all functions required before initiating a scan.

► Scan Window

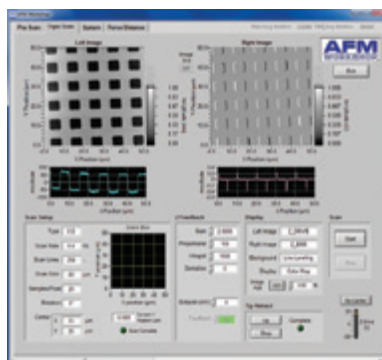

Once the steps in the pre-scan window are completed, the scan window is used for measuring images. Scan parameter, Z feedback parameters, and image view functions may be changed with dialogs on this screen.

► Force/Distance Curves

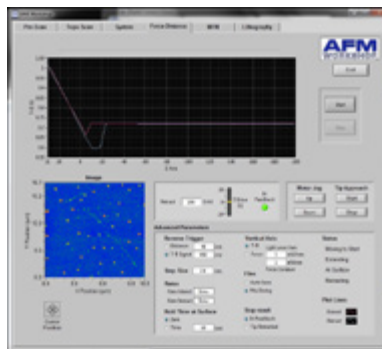

Optional Advanced Force/Distance software may be purchased. This option requires a TS-17Z Z scanner.

► LabVIEW™ Window

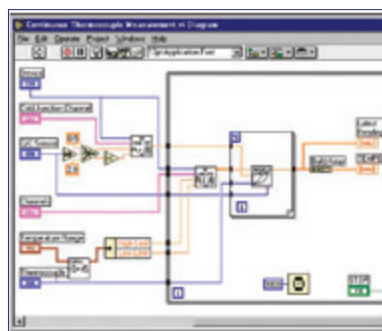

LabVIEW™ is an industry-standard programming environment for controlling instrumentation. All the software for the LS-AFM is written with LabVIEW™ and can be readily customized for specialized applications.

Any instrumentation already using LabVIEW™ can be added to the LS-AFM to create new capabilities.

IMAGE ANALYSIS SOFTWARE

Included with the LS-AFM is Gwyddion open source SPM image analysis software. This complete image analysis package has all the software functions necessary to process, analyze and display SPM images.

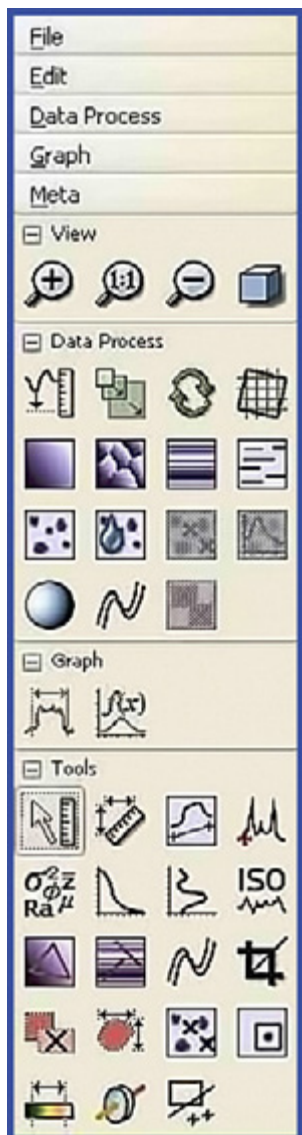

- » Visualization: false color representation with different types of mapping
- » Shaded, logarithmic, gradient- and edge-detected, local contrast representation, Canny lines
- » OpenGL 3D data display: false color or material representation
- » Easily editable color maps and OpenGL materials
- » Basic operations: rotation, flipping, inversion, data arithmetic, crop, resampling
- » Leveling: plane leveling, profiles leveling, three-point leveling, facet leveling, polynomial background removal, leveling along userdefined lines
- » Value reading, distance and angle measurement
- » Profiles: profile extraction, measuring distances in profile graph, profile export
- » Filtering: mean, median, conservative denoise, Kuwahara, minimum, maximum, checker pattern removal
- » General convolution filter with user-defined kernel
- » Statistical functions: Ra, RMS, projected and surface area, inclination, histograms, 1D and 2D correlation functions, PSDf, 1D and 2D angular distributions, Minkowski functionals, facet orientation analysis
- » Statistical quantities calculated from area under arbitrary mask
- » Row/column statistical quantities plots
- » ISO roughness parameter evaluation
- » Grains: threshold marking and un-marking, watershed marking
- » Grain statistics: overall and distributions of size, height, area, volume, boundary length, bounding dimensions
- » Integral transforms: 2D FFT, 2D continuous wavelet transform (CWT), 2D discrete wavelet transform (DWT), wavelet anisotropy detection
- » Fractal dimension analysis
- » Data correction: spot remove, outlier marking, scar marking, several line correction methods (median, modus)
- » Removal of data under arbitrary mask using Laplace or fractal interpolation
- » Automatic XY plane rotation correction
- » Arbitrary polynomial deformation on XY plane
- » 1D and 2D FFT filtering
- » Fast scan axis drift correction
- » Mask editing: adding, removing or intersecting with rectangles and ellipses, inversion, extraction, expansion, shrinking
- » Simple graph function fitting, critical dimension determination
- » Force-distance curve fitting
- » Axes scale calibration
- » Merging and immersion of images
- » Tip modeling, blind estimation, dilation and erosion

VIDEO MICROSCOPE

A video optical microscope in an AFM serves three functions: aligning the laser onto the cantilever in the light level of the AFM, locating surface features for scanning, and facilitating probe approach. The LS-AFM includes a high performance video optical microscope along with a 3 megapixel camera, light source, microscope stand, and Windows software for displaying images.

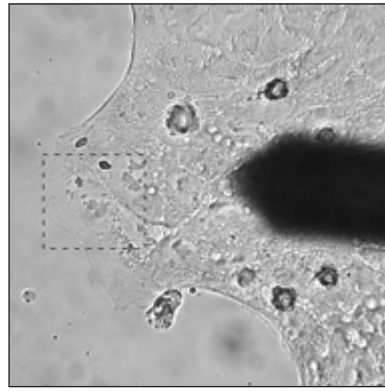

Inverted optical microscope image of Caco-2 cells in the LS-AFM. Clearly visible is the AFM cantilever on the right side of the image. A box identifies the area for AFM scanning.

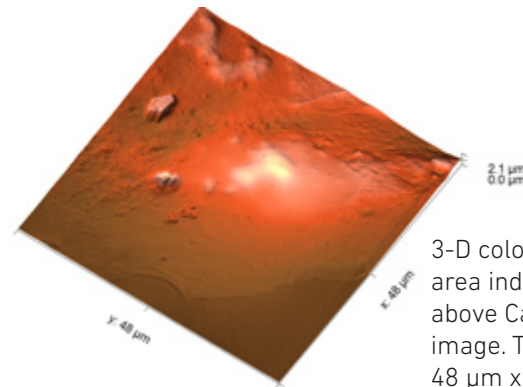

3-D color scale AFM image of the area indicated with the box in the above Caco-2 cell inverted optical image. The scan range is 48 μm x 48 μm .

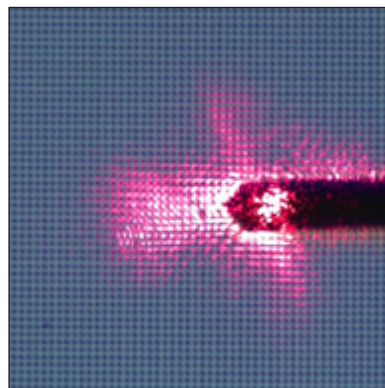

Laser alignment is greatly facilitated with the video optical microscope. This vibrating cantilever is 250 μm long. The red spot is from the laser reflecting off the cantilever.

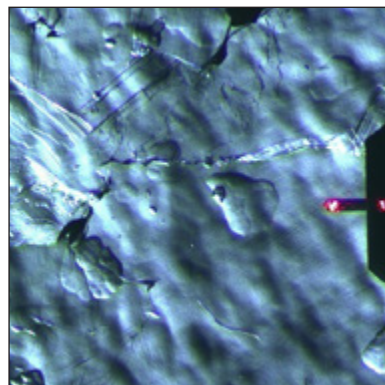

The video optical microscope zooms in to show an HOPG sample surface and the AFM cantilever.

PROBE HOLDER/ EXCHANGE

The LS-AFM utilizes a unique probe holder/exchange mechanism. Probes are held in place with a spring device that mates with a probe exchange tool.

This combination makes changing probes fast and easy on the LS-AFM.

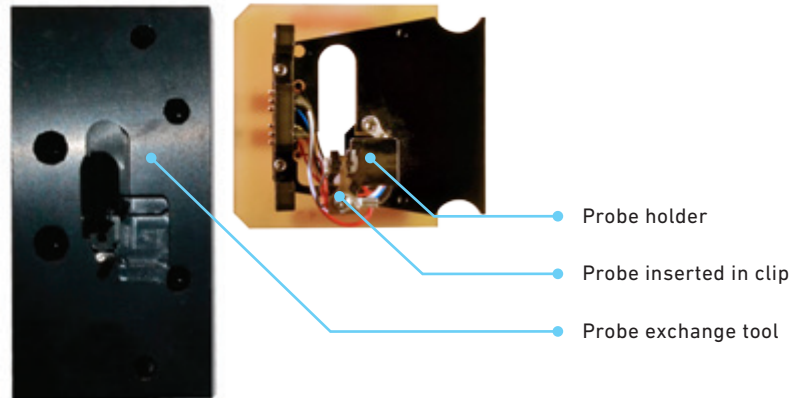

SCANNING MODES

Standard with every LS-AFM are nonvibrating (NV) mode and vibrating (V) modes for creating topography scans.

Additional modes included with the product are lateral force imaging and phase mode imaging.

Any scanning mode that can be implemented with a light lever AFM is possible with the LS-AFM.

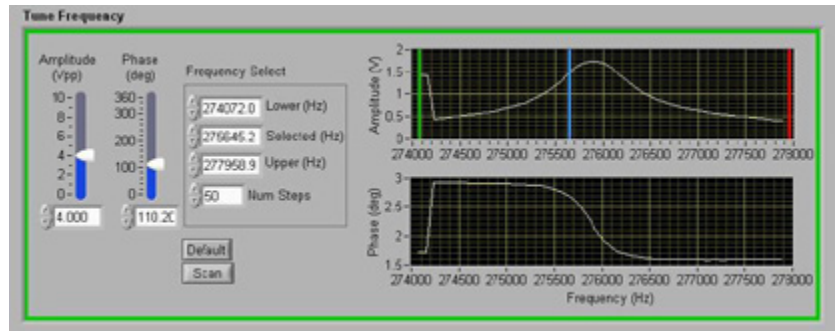

With the window above the resonance frequency of a cantilever is readily measured. Additionally, the phase characteristics of the probe-sample interaction may be captured.

INSTRUMENT INNOVATION

As with all AFMWorkshop products, the LS-AFM's mechanical design documents, schematics and software source code are available to customers. This information enables customers to modify the LS-AFM and to create new AFM instrumentation for novel applications.

SPECIFICATIONS

▶ 40 Micron XYZ Scanner

» Type	Modified Tripod
» XY Linearity	< 1%
» XY Range	> 40 μm
» XY Resolution	< 3 nm closed loop < 0.3 nm open loop
» XY Actuator type	Piezo
» XY Sensor type	Strain Gauge
» Z Range	> 16 μm
» Z Linearity	< 5 %
» Z feedback noise	< 0.2 nm
» Z Actuator Type	Piezo
» Z Sensor type	Strain Gauge

▶ Light Lever AFM Force Sensor

» Probe Types	Industry-standard
» Probe Insertion	Manual
» Probe Exchange	Tool
» Probe Holding Mechanism	Clip Vibrating Mode Piezo Electrical Connector to Probe
» Laser/Detector Adjustment Range	+/- 1.5 mm
» Adjustment Resolution	1 μm
» Minimum Probe to Objective	25 mm
» Laser Type	670 nm Diode, < 3 mW
» Laser Focus	< 25 μm
» Detector	
Type	4 Quadrant
Band Width	> 500 kHz
Signals Transmitted	TL, BL, TR, BR
Gain	Low, High Settings
» Probe sample angle	10°

▶ Digital Data Input Output

» Connection	USB
» Scanning DAC	
Number	2
Bits	24
Frequency	7 kHz
» Control DAC	
Number	2
Bits	14
Frequency	2 kHz
» ADC	
Number	8
Bits	14
Frequency	48 kHz

▶ Z Motion

» Type	Direct Drive
» Range	25 mm
» Drive Type	Stepper Motor
» Min. Step Size	330 nm
» Slew Rate	8 mm/minute
» Limit Switch	Top, Bottom
» Control	Software – Rate, Step Size

▶ Analog Electronics

» Vibrating Mode	
Freq Range	2 kHz – 800 kHz
Output Voltage	10 Vpp
Demod. Freq	TBD
» Z Feedback	
Type	PID
Bandwidth	> 3 kHz
Sample Hold	Yes
Voltage	0 – 150 V
» xy Scan	
Voltage	0 – 150 V
Bandwidth	> 200 Hz
Pan & Zoom	22 Bits
» Tip Approach Cutoff	< 20 μm sec.

▶ Software

» Environment	LabVIEW™
» Operating System	Windows
» Image Acquisition	Real Time Display (2 of 8 channels)
» Control Parameters	
PID	Yes
Setpoint	Yes
Range	Yes
Scan Rate	Yes
Image Rotate	0 and 90°
» Laser Align	Yes
» Vibrating Freq. Display	Yes
» Force Distance	Yes
» Tip Approach	Yes
» Oscilloscope	Yes
» Image Store Format	Industry-standard
» Image Pixels	16 x 16 to 1024 x 1024
» H.V. Gain Control	XY and Z
» Real Time Display	Line Level, Light Shaded, Grey Color Palette System Window
» Calibration	Yes
» Probe Center	Yes

SPECIFICATIONS CONTINUED...

▶ Video Microscope

	Minimum Zoom	Maximum Zoom
Field of view	2 X 2 mm	300 X 300 μm
Resolution	20 μm	2 μm
Working Distance	114 mm	114 mm
Magnification	45 X	400X

▶ Computer

- » Industry-standard Computer & Monitor (laptop available upon request)
- » Windows
- » AFMWorkshop LabVIEW.exe installed

▶ Stage

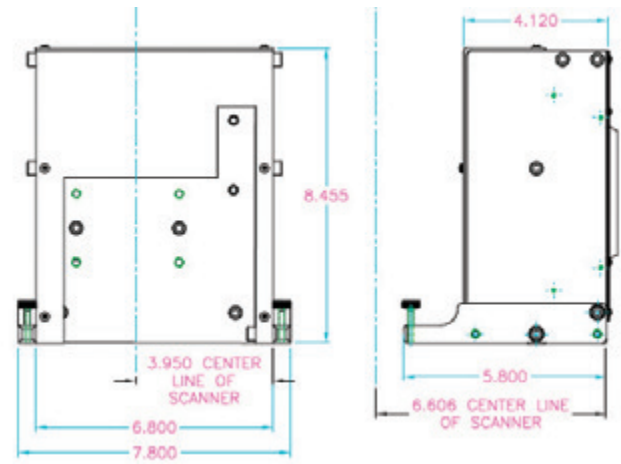

Back and side view of the LS-AFM stage without the AFM/video microscope. The feet at the bottom may be removed if the stage is rigidly mounted to a surface.

* Z Noise performance depends greatly on the environment the LS-AFM is used in. Best Z noise performance is obtained in a vibration-free environment. Z noise on inverted microscope is < 1 nm.

** Every effort is made to present accurate specifications within this document. However, due to circumstances beyond the control of AFMWorkshop, specifications are subject to change without notice.