

# Mechelle 5000

Simultaneous High Bandpass and High Resolution Echelle Spectrograph

## Key Specifications

- ✓ Large simultaneous bandpass 200 – 975 nm
- ✓ Resolution power up to 6,000
- ✓ Low crosstalk patented optical design
- ✓ Built-in temperature correction

## Key Applications

- ✓ Laser Induced Breakdown Spectroscopy (LIBS)
- ✓ Plasma studies
- ✓ Elemental material & biomaterial analysis



# Introducing Mechelle 5000

Andor's Mechelle ME5000 spectrograph has been designed to provide simultaneous recording of a wide wavelength range (200 - 975 nm) in one acquisition.

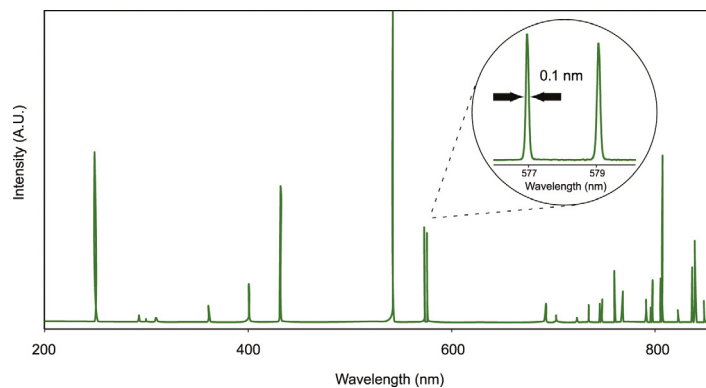
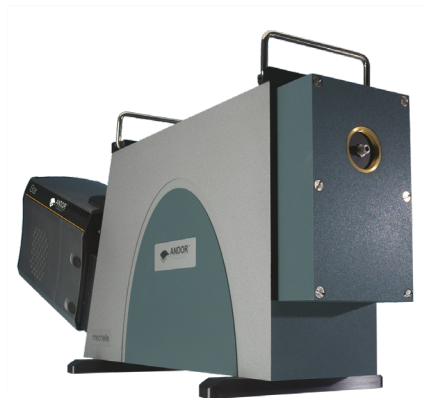

**Hg-Ar spectrum**  
 Acquired with Mechelle 5000,  
 1024 x 1024 pixel Gen 2 Andor  
 iStar and 10  $\mu$ m slit width

## Features and Benefits

Feature	Benefit
Compact and robust design with no moving components	Stable and reproducible design in laboratory environment.
Simultaneous high resolution and high bandpass	Single acquisition covers 775 nm with resolution power / $\Delta$ up to 6,000 (CCD) or 5,000 (ICCD). <sup>•1</sup>
Patented optical design	Ensures maximum resolution and high bandpass with extremely low crosstalk. Channel height options of 5, 3 or 1 pixel to further reduce crosstalk. <sup>•2</sup> Optical adjacent crosstalk better than $1 \times 10^{-2}$ <sup>•3</sup>
Auto-temperature correction	Corrects for the variation of prisms optical refractive index with temperature.
Ultra low stray light	Maximises signal-to-noise ratio, better than $1.5 \times 10^{-4}$ <sup>•4</sup>
N <sub>2</sub> purged	Sealed, nitrogen backfilled enclosure minimizes degradation in performance, due to moisture-laden air, especially in the UV region.
Pre-aligned detector/spectrograph solution	Enables fast, efficient experimental set-up.
Low F/7 aperture	High collection efficiency.
Wide range of accessories available	Including fibre optics, slits, alignment laser, collector/collimator and calibration lamps.
Andor Solis software	Automatically extracts a full wavelength calibrated spectrum from a complex echelle image and offers system advanced data manipulation capabilities.
User-friendly tagging	Easy tagging of known atomic species at the press of a button.

# Technical Information

## Reciprocal Dispersion

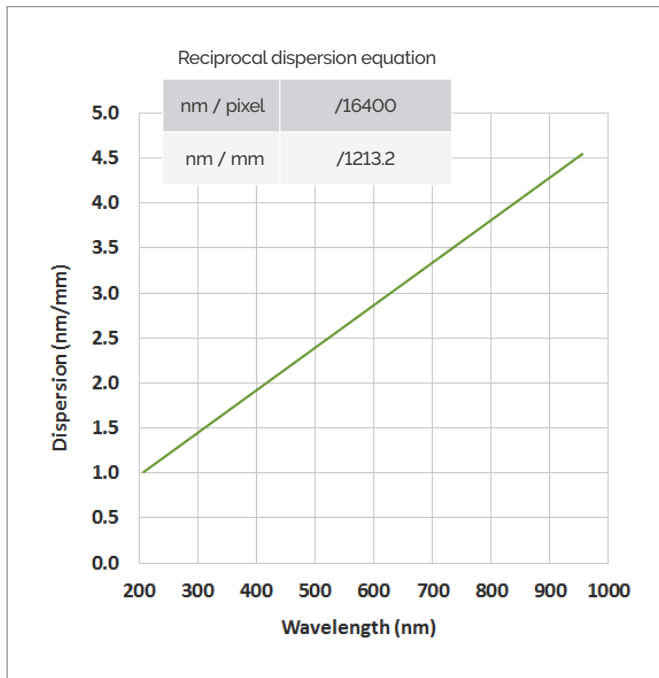

## Resolution Power vs Slit Width (typ.)

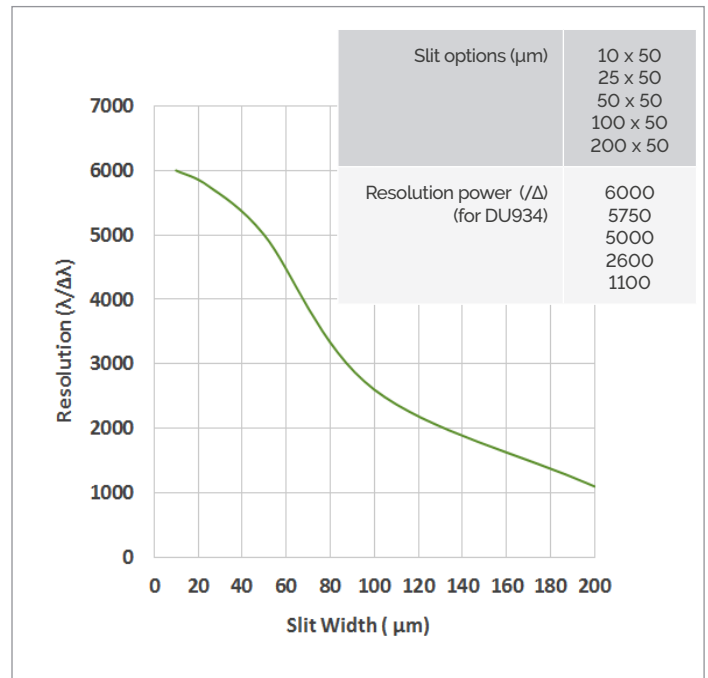

## Mechelle 5000 Spectral Resolution vs ICCD Spatial Resolution (typ.)

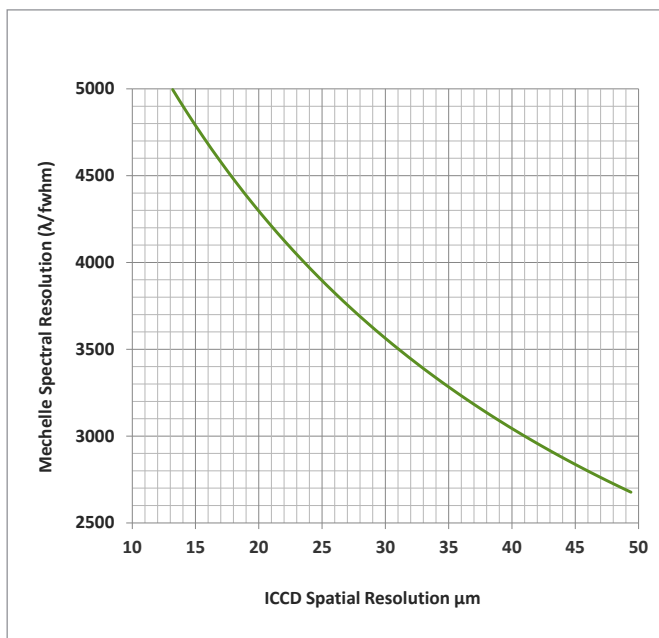

## Echellogramme example (broadband source)

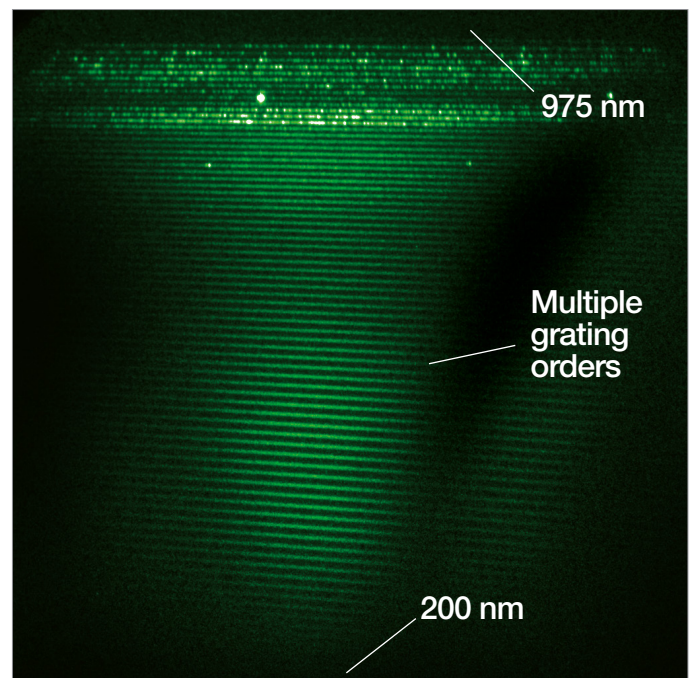

Echellogram of Deuterium-Tungsten light source acquired with Mechelle 5000 and iStar ICCD

# Creating the Optimum Product for You

## Step 1. Select the Spectrograph model



Spectrograph

Quote the model number below:

Description	Order Code
Mechelle 5000 echelle spectrograph	ME5000

## Step 2 Select the required accessories and adapters



Accessories & Adapters

The Mechelle 5000 is supplied with a 90  $\mu\text{m}$  fibre optic cable, UV, SMA-SMA, 2 m and an SMA adaptor. To access the best spectral resolution performance, one of the following slit options must be ordered:

Description	Order Code
Mechelle 25 x 25 $\mu\text{m}$ slit <sup>•5</sup>	ME-SLT-25x25
Mechelle 10 x 50 $\mu\text{m}$ slit <sup>•5</sup>	ME-SLT-10x50
Mechelle 50 x 25 $\mu\text{m}$ slit <sup>•5</sup>	ME-SLT-50x25
Mechelle 25 x 50 $\mu\text{m}$ slit <sup>•5</sup>	ME-SLT-25x50
Mechelle 50 x 50 $\mu\text{m}$ slit <sup>•5</sup>	ME-SLT-50x50
Mechelle 100 x 50 $\mu\text{m}$ slit	ME-SLT-100x50
Mechelle 200 x 50 $\mu\text{m}$ slit	ME-SLT-200x50

Other optional accessories:

Description	Order Code
Mercury-Argon calibration lamp with SMA connector	ACC-LK-HGAR-OCE
Deuterium-Halogen lamp, radiometrically calibrated (230 to 1,050 nm)	LK-DHRD-OCE-CAL
Mechelle shutter unit (recommended when using iKon-M DU934P-yy-9FL), 1 Hz maximum frequency <sup>•6</sup>	ME-SHT-9002

## Step 3. Select your camera

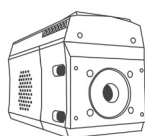

Camera

Camera	Description	Order Code
<b>iStar CCD</b>	Intensified fast gated CCD camera, 1024 x 1024 matrix with 13 $\mu\text{m}$ pixels, $\varnothing$ 18 mm Gen 2 intensifiers, gating down to 2 ns or better	DH334T-18x-xx
<b>iStar sCMOS</b>	Intensified fast gated sCMOS camera, 2560 x 2160 matrix with 6.5 $\mu\text{m}$ pixels, $\varnothing$ 18 mm Gen 2 intensifiers, gating down to 2 ns or better, fast frame rates up to 50 Hz	ISTAR-SCMOS-18x-xx
<b>iKon-M CCD</b>	CCD camera, 1024 x 1024 matrix with 13 $\mu\text{m}$ pixels, deep TE-cooling to $-100^\circ\text{C}$ for non-gated or long exposure times, no mechanical shutter	DU934P-yy-9FL

Refer to the camera specification sheets for further information

## Step 4. Select your software



Software

The Mechelle 5000 requires the following software:

**Solis for Spectroscopy** A 32-bit and fully 64-bit enabled application for Windows (8, 8.1 and 10) offering rich functionality for data acquisition and processing. AndorBasic provides macro language control of data acquisition, processing, display and export. Control of Andor Shamrock spectrographs and a very wide range of 3<sup>rd</sup> party spectrographs is also available.

# Mechanical and Connectivity Information

## Product Drawings

Product drawings with iStar sCMOS/CCD. Dimensions in mm [inches]

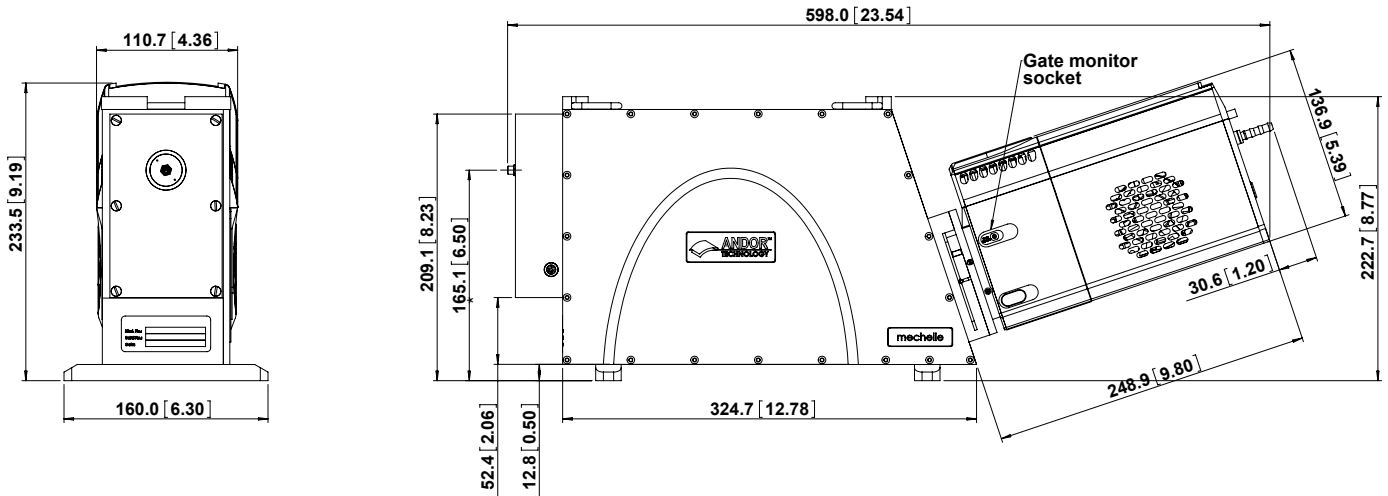

## Mechanical & Electrical Specifications

Optical path height	165.1 mm [6.50 inches] 155.1 mm [6.1 inches]
Camera flange mounting	4 off, 6/32 x 3/8 UNC
Weight	Mechelle alone: 10 kg [22 lbs] With iStar CCD or sCMOS attached: 14.2 kg [31 lbs 4 oz]
Temperature correction	I <sup>2</sup> C bus
Optional shutter control	TTL signal for shutter

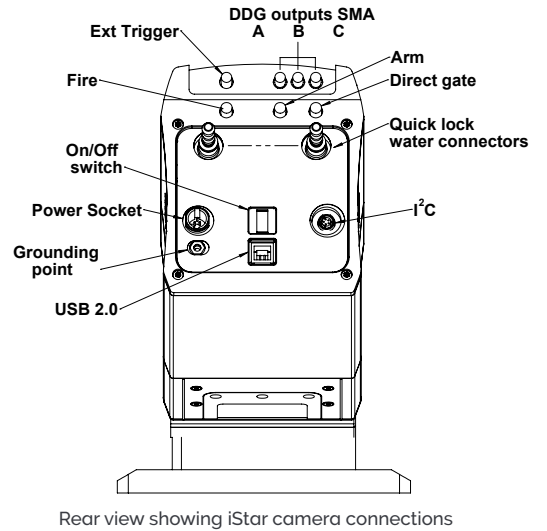

## Have you found what you are looking for?

### Need flexibility on resolution and bandpass?

The Shamrock Czerny-Turner-based series offer an interchangeable triple grating turret interface.

### Need higher resolution?

Shamrock 500i and 750 offer spectral resolution options down to 0.02 nm.

### Need multi-modal platform to accommodate different experiment type?

The Kymera and Shamrock series offer multi output options to accommodate different detection technologies, multi-input options to accommodate simultaneous experiments and multi-grating turret to accommodate different resolution and wavelength ranges including SWIR.

### Need different resolution and bandpass?

Kymera and Shamrock Czerny-Turner spectrograph series offer motorised multi-grating turret, slits, filter wheel and wide range of light coupling accessories and detectors.

# Our Cameras for Spectroscopy

Spectroscopy-based diagnostics in the fields of Material Science, Chemistry, Life Science or Fundamental Physics & Optics rely on the capture and analysis of optical and chemical signatures with a high degree of precision.

Andor's range of detectors offer a wide range of sensitivity, time-resolution and sensor formats to best suit specific experimental conditions from UV to SWIR, nanosecond to hours time resolution, high photon flux to single photon with super dynamic range and resolution.

## High Sensitivity & Dynamic Range

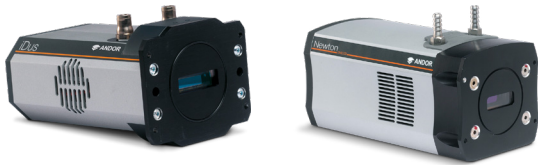

- ✓ Long exposure
- ✓ High sensitivity UV-SWIR
- ✓ Large pixel well depths
- ✓ High resolution matrix

iDus CCD & InGaAs | Newton CCD & EM

## ns to $\mu$ s Time-Resolution



- ✓ Nanosecond gating
- ✓ High sensitivity down to single photon
- ✓ On-head DDG with ps accuracy

iStar CCD & sCMOS

## kHz Spectral Rates



- ✓  $\mu$ s to ms time-resolution
- ✓ High sensitivity down to single photon
- ✓ High resolution matrix

Newton CCD & EMCCD | iXon EMCCD |  
Zyla sCMOS | Marana sCMOS

## Extended Multi-fibre Spectroscopy

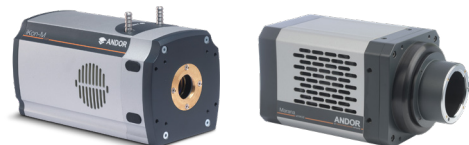

- ✓ Large area sensors
- ✓ Ultrafast sCMOS and EMCCD options
- ✓ High sensitivity down to single photon

iKon-M CCD | iXon EMCCD | Zyla sCMOS |  
Marana sCMOS | iStar CCD & sCMOS

Learn more about our detector range [here](#).



Learn more about our spectrograph solutions [here](#).

# Order Today

Need more information? At Andor we are committed to finding the correct solution for you. With a dedicated team of technical advisors, we are able to offer you one-to-one guidance and technical support on all Andor products.

For a full listing of our local sales offices, please see: [andor.com/contact](http://andor.com/contact)

Our regional headquarters are:

## Europe

Belfast, Northern Ireland  
Phone +44 (28) 9023 7126  
Fax +44 (28) 9031 0792

## Japan

Tokyo  
Phone +81 (3) 6732 8968  
Fax +81 (3) 6732 8939

## North America

Concord, MA, USA  
Phone +1 (860) 290 9211  
Fax +1 (860) 290 9566

## China

Beijing  
Phone +86 (10) 5884 7900  
Fax +86 (10) 5884 7901

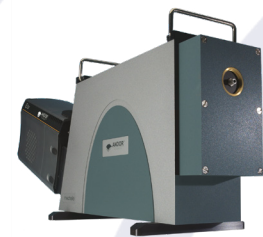

### Footnotes: Specifications are subject to change without notice

- The spectral resolution is measured using an Andor DU934P-yy-9FL shutterless camera. This translates to a FWHM of 0.04 nm at 200 nm or 0.1 nm at 500 nm for an Andor DU934P-yy-9FL CCD camera, measured using a 50  $\mu\text{m}$  wide slit. iStar DH334T typical spectral resolution with a 50  $\mu\text{m}$  wide slit yield typical resolution of 0.05 nm at 200 nm and 0.125 nm at 500 nm.
- The channel height is selectable through the software.
- Crosstalk measured with a 50 x 25  $\mu\text{m}$  slit at the 546 nm line, with a channel height of 5 pixels.
- Stray light as measured at 20 nm from a 633 nm laser line.
- When working with narrow slits (< 50  $\mu\text{m}$ ), use of a larger core diameter fibre optic is strongly recommended e.g. 100 or 200  $\mu\text{m}$ .
- The shutter is optional when using the Mechelle with Andor's New iStar intensified CCD camera. However it is recommended to protect the image intensifier photo-cathode from photo-bleaching during experimental 'dead-time'.
- iStar DH334T models with  $\varnothing$  18 mm intensifier.

### Items shipped with your spectrograph:

- 1x Electronic copy of software (if ordered)
- 1x I<sup>2</sup>C, shutter & temperature cable
- 1x SMA adapter
- 1x 90  $\mu\text{m}$  core, UV-enhanced fibre optic cable, 2 m

### Laser Safety Labels for Laser Accessories



### Operating and Storage Conditions

- Operating Temperature: 20°C to 30°C ambient
- Relative Humidity: < 70% (non-condensing)
- Storage Temperature: -25°C to 50°C



EPICS



$\mu$ Manager

Windows is a registered trademark of Microsoft Corporation.  
Labview is a registered trademark of National Instruments.  
Matlab is a registered trademark of The MathWorks Inc.