

C-RED 2 ER

1.9 μm & 2.2 μm Extended Range SWIR Camera

Key Specifications

- ✓ 640 x 512 InGaAs sensor
- ✓ SWIR 1.1 - 1.9 μm or 1.3 - 2.2 μm
- ✓ 15 μm pixel pitch
- ✓ 70% QE, wavelength from 0.9 to 1.7 μm
- ✓ Up to 600 fps full frame
- ✓ <40 e- or <50 e- read noise

Key Applications

- ✓ Astronomy & Adaptive Optics
- ✓ LiDAR
- ✓ Long Range Imaging
- ✓ Hyper/Multispectral Imaging
- ✓ Quality/Production Control
- ✓ Laser beam characterization
- ✓ Spectroscopy



Introducing C-RED Extended Range (ER)



C-RED 2 ER is a highly sensitive extended InGaAs camera series for extended SWIR imaging and opens new imaging and sensing opportunities for life science, research, laser measurements, and industrial applications. C-RED 2 ER are VGA (640 x 512 pixels) detectors with a 15 μm pixel pitch for high resolution, and with peak quantum efficiency > 70%. All models are able to run at 600 fps, full frame, and up to 32066 fps in cropping mode. All models have an integrated two-stage thermoelectric cooler, enabling cooling capability down to -40 or -55°C (model dependent).

C-RED 2 ER is available with two options of InGaAs detectors with shifted sensitivity ranges:

- ✓ C-RED 2 ER 1.9 μm is sensitive in the range of 1.1 to 1.9 μm
- ✓ C-RED 2 ER 2.2 μm is sensitive in the range of 1.2 to 2.2 μm

C-RED 2 ER 1.9 μm and C-RED 2 ER 2.2 μm are complementary to C-RED 2 in terms of sensitivity, as they cover the high end of the SWIR spectrum. The C-RED 2 ER 1.9 μm achieves a readout noise < 50 e- while C-RED 2 ER 2.2 μm readout noise is < 40 e-.

The development of extended range detectors based on InGaAs technology is a recent breakthrough in imaging. With a double thermoelectric cooling system, the camera is a straightforward solution for imaging in the far end of the SWIR spectrum without the cryogenic cooling required for HgCdTe.

High Quality Imaging in Extended Range SWIR

Standard InGaAs has a long cutoff wavelength of 1700 nm. Introducing more Indium into GaAs enables the detection of longer wavelengths, this is called "extended wavelength InGaAs". Variation in the substrate composition results in lattice-mismatch artefacts, which degrade image quality. First Light Imaging has developed a specific correction to compensate the artefacts live.

Visible versus SWIR and ER-SWIR images of a plastic bottle filled with water. The bottle is opaque in the visible range, while ER-SWIR increases the contrast compared to SWIR. Courtesy of First Light Imaging.

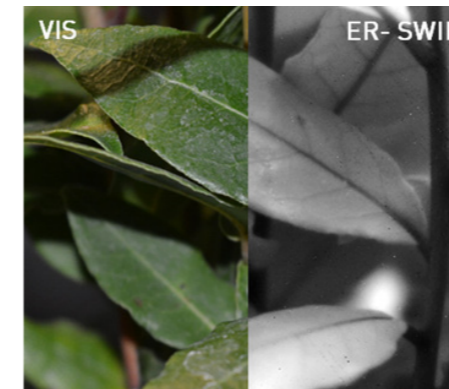
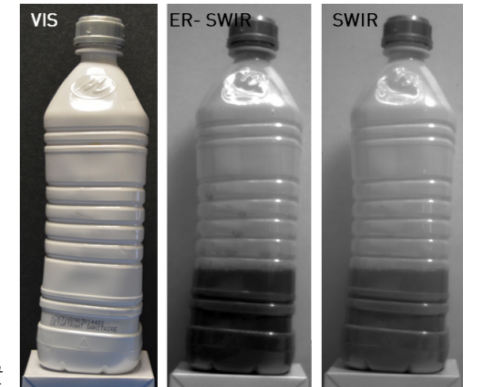

Visible versus ER-SWIR images of bay leaves. Courtesy of First Light Imaging.

Agriculture and food inspection

Water has four absorption bands within the infrared region, at wavelengths 1200 nm, 1450 nm, 1940 nm and 2950 nm. Measuring the absorption of thin food slices or foliage at these wavelengths enables quantitative measurement of their water content. On thicker objects, such as fruits and vegetables, the absorption properties allow the detection of moisture or defects that are imperceptible in the visible range (by the naked eye). This is particularly useful for food sorting applications and observation of crop fields.

Life Science Research

Imaging in the range 650 – 950 nm has been widely used for clinical and preclinical fluorescence imaging. More recently, cameras sensitive to the NIR-II range have allowed imaging between 1100 – 1350 nm; used for in vivo small animal imaging and more recently for clinical applications. A further extended spectral range 1600 – 1870 nm optimises the scattering and absorption of tissues, hence the penetration depth of light in tissues and is ideal for deep brain imaging. Other applications such as Optical Coherence Tomography (OCT) will also benefit from the longer penetration depth of light.

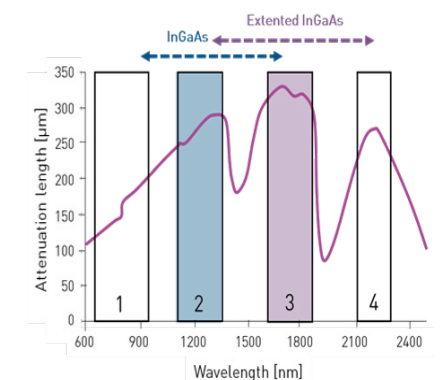

Transmittance in brain tissue of 200 μm thicknesses. Four spectral regions are identified. The third wavelength region can be exclusively detected by extended range cameras.

Technical Specifications

Model Specific Specifications •¹

Sensor Specifications	C-RED 2 ER 1.9 μm	C-RED 2 ER 2.2 μm
Full sensitivity range (QE >10%)	1100 - 1900 nm	1300 - 2150 nm
Quantum Efficiency >70%	1150 - 1800 nm	1380 - 2050 nm
Maximum speed Full Frame	600 fps	
Readout Noise at high gain, Tint @ 50 μs, 600 fps Full Frame	<50 (@ -40°C) e-	<40 (@ -55°C) e-
Dark Current (looking at a 20°C target)	20 (@ -40°C) ke/p/s	120 (@ -55°C) ke/p/s
Quantization	14 bit	
Operability	> 95 (@ -40°C)%	contact us
Image Full well capacity at low gain, 600 fps	1500 ke-	
Image Full well capacity at med gain, 600 fps	130 ke-	
Image Full well capacity at high gain, 600 fps	34 ke-	
Maximum speed in 32 x 4 (min)	32066 fps	
Maximum speed in 320 x 256	1779 fps	

Additional Features	All models
Output	USB 3.1 Gen 1 and CameraLink® full
Optical interface	C-Mount
Operating temperature	-5° to 35° C (with regards to dew point)
On camera image optimisations	Embedded image corrections
Triggering	LVTTTL/LVDS synchronization
Software	Graphical User Interface: First Light Vision Software Development Kit: (C, C++, C#, Python, MatLab) / LabVIEW / μManager

Lines	Frame rate at 600 fps readout speed CameraLink® Output						
	Columns						
	32	64	128	256	512	640	
4	32066	31512	30458	28548	25367	24029	
8	28108	27348	25945	23532	19840	18397	
16	22542	21631	20015	17413	13819	12526	
32	16147	15254	13736	11455	8599	7646	
64	10302	9596	8440	6801	4898	4297	
128	5975	5509	4765	3752	2632	2291	
256	3247	2975	2547	1978	1367	1184	
512	1697	1549	1319	1016	697	602	

For USB 3 Output: Max 9999 FPS

Product Drawings

Dimensions in mm (inches)
Weight: 900 g

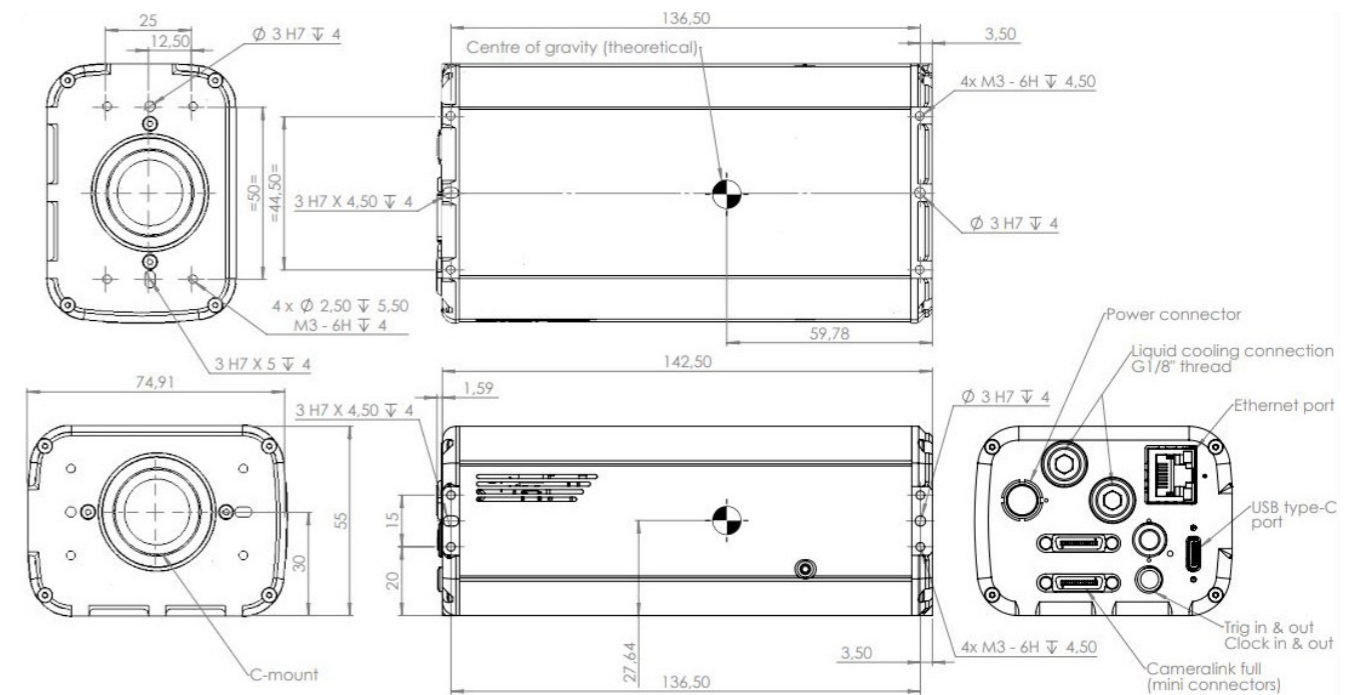

Quantum Efficiency (QE) Curve

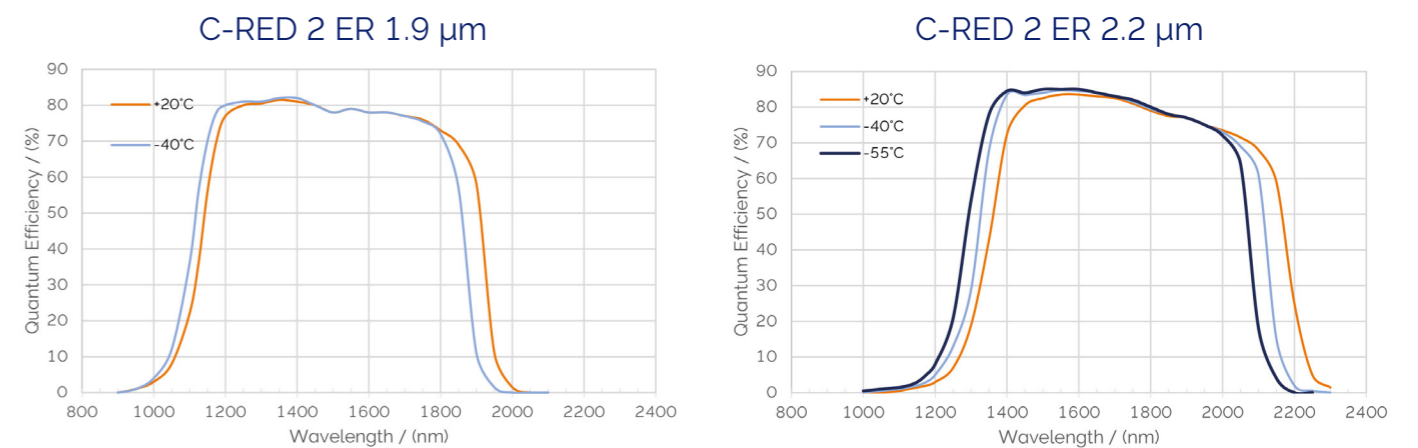

Creating The Optimum Product for You

Step 1. Select the camera type

Camera Type	Description	Code
	C-RED 2 ER 2.2: 640 x 512 Extended InGaAs camera, 600 fps, <40 e-, wavelength 1.3-2.2 μm	PAC-CR2-SERB2
	C-RED 2 ER 1.9: 640 x 512 Extended InGaAs camera, 600 fps, <50 e-, wavelength 1.1-1.9 μm	PAC-CR2-SERB1

Step 2. Select the required accessories

	Description	Order Code
 Accessories	Cooling pack	PAC-COO-200-000
	Mounting plate (C-RED 2 and C-RED 2 ER only)	ACC-MOU-CR2-000
	Quick coupling set	ACC-QCS-CAM-001
	Synchro cables 1 m	ACC-CAB-SYN-000
	Synchro cables 3 m	ACC-CAB-SYN-001
	Camera Link® cables 5 m	ACC-CAB-CLF-000
	Camera Link® cables 10 m	ACC-CAB-CLF-001
	Matrix Grabber CL RAD EV 1G CLSF	ACC-GRA-CLF-000

Step 3. Software

 Your product is provided with the following software options:

- Graphical User Interface: First Light Vision
- Software Development Kit: (C, C++, C#, Python, MatLab) / LabVIEW / μManager

Meet the Extended Cameras Family

C-RED 2 Lite



C-RED 2 Lite is the stabilized version of C-RED 2, able to run at 600 fps with 30 e- readout noise.

- ✓ Free space optics
- ✓ Laser communications
- ✓ Quantitative spectral imaging
- ✓ Hyper/multispectral imaging
- ✓ Thermography
- ✓ Non destructive inspection
- ✓ Laser beam profiling

[Read More](#)

C-RED 2



Ultra high speed, low noise, short wave infrared camera, able to run at 600 fps with a readout noise under 30 electrons and a very low dark current <600 e-/p/s.

- ✓ Astronomy
- ✓ Adaptive Optics
- ✓ Fluorescence microscopy research
- ✓ Hyperspectral imaging
- ✓ Low visibility imaging
- ✓ Semicon inspection
- ✓ Quality / production control

[Read More](#)

C-RED 3



Specially designed for short exposure times applications, C-RED 3 is a very compact high speed VGA uncooled camera for short wave infrared (SWIR) imaging.

- ✓ Free space optical communications
- ✓ Semiconductor inspection
- ✓ Quality/production control
- ✓ Adaptive optics
- ✓ Laser beam profiling
- ✓ Hyperspectral imaging
- ✓ Thermography

[Read More](#)

C-RED One



C-RED One is an unique photon counting SWIR camera based on an e-APD MCT sensor (320x256 pixels), running at 3500 frames per second, for high-end scientific applications:

- ✓ Astronomy
- ✓ Adaptive Optics
- ✓ Space debris tracking
- ✓ Secure laser communications
- ✓ Long range surveillance and tracking
- ✓ Spectroscopy
- ✓ Hyperspectral imaging

[Read More](#)

Order Today

Need more information? At Andor we are committed to finding the correct solution for you. With a dedicated team of technical advisors, we are able to offer you one-to-one guidance and technical support on all Andor products.

For a full listing of our local sales offices, please see: andor.oxinst.com/contact

Our regional headquarters are:

Europe

Belfast, Northern Ireland
Phone +44 (28) 9023 7126
Fax +44 (28) 9031 0792

North America

Concord, MA, USA
Phone +1 (860) 290 9211
Fax +1 (860) 290 9566

Japan

Tokyo
Phone +81 (3) 6744 4703
Fax +81 (3) 3446 8320

China

Beijing | Shanghai | Guangzhou
Phone +86 (400) 678 0609
Fax +86 (10) 5884 7901



Items shipped with your camera:

- 1x Camera (model as ordered)
- 1x Power supply
- 1x Power supply cable
- 1x USB cable
- 1x Quick start guide

Minimum Computer Requirements:

RAM: 8 GB minimum
Processor: Intel® Core™ i5 or higher
Screen resolution: at least 1920 x 1080
See [system requirements](#) for more information.

Operating and Storage Conditions

- Operating Temperature: -5°C to 35°C
- Relative Humidity: < 80% (non-condensing)
- Storage Temperature: -40°C to 50°C

Power Requirements

- 100 - 240 VAC 50 - 60 Hz
- Max. power consumption: 90 W

Footnotes: Specifications are subject to change without notice

1. Average values observed.