

Attension Theta

Flex and Flow modules and accessories

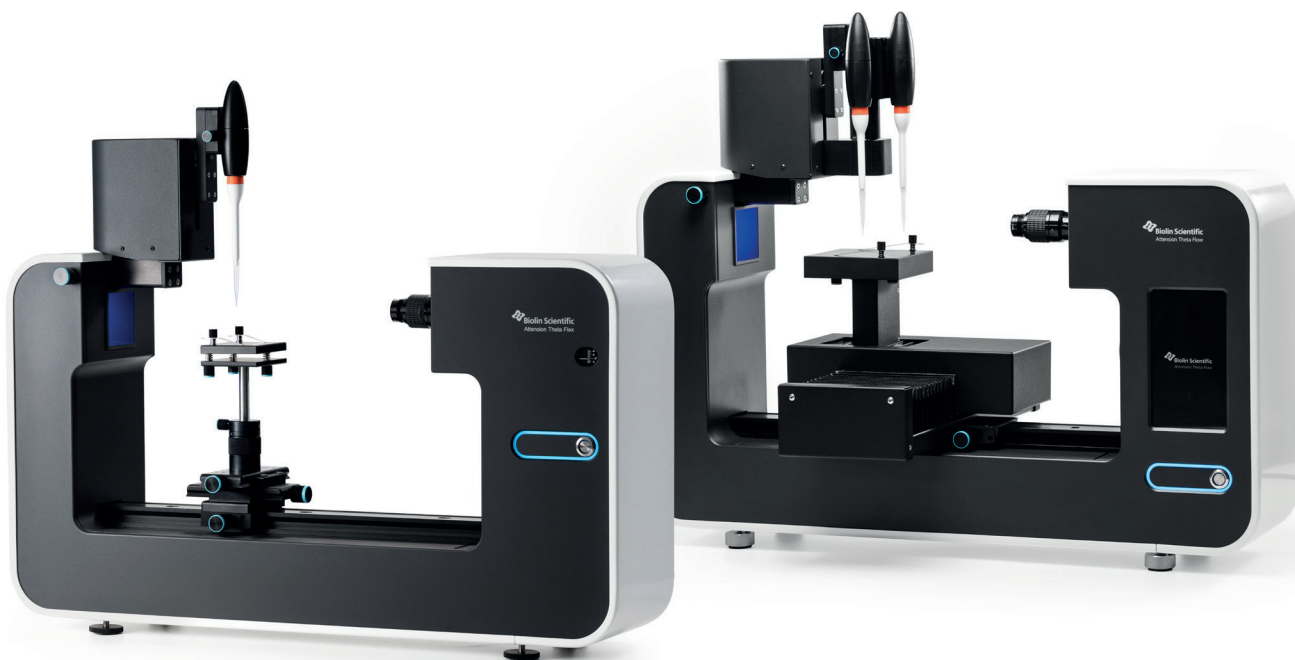

Modules and Accessories

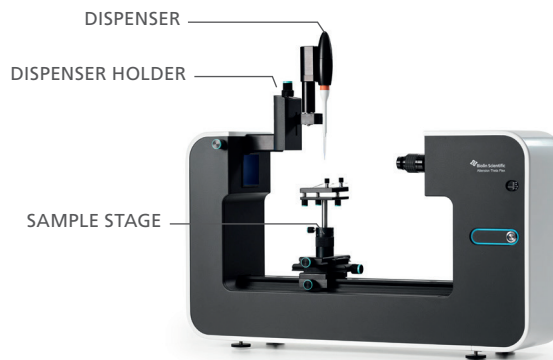

Dispensers

Dispenser creates the droplets used in measurements. Attension® offers a full range of dispensers from manual to automatic, from single liquid to multiliquid, and from microliter to picoliter scale.

Manual precision syringe dispenser (C205M)

Accurate manual drop formation when automation isn't required. Continuous adjustment range. Droplet volume can be seen live in the OneAttension software.

Automatic single liquid dispenser (C201)

Automatic drop formation using syringes and needles. Dynamic contact angle (DCA) measurements with the needle method. Recommended dispenser for pulsating drop studies.

Automatic disposable tip dispenser (C311-300)

Automatic drop formation without the need for needle or syringe cleaning. For maximized easy-of-use. Combine two C311-300s for automatic double liquid dispensing for convenient surface free energy studies. Can be used with disposable needles as well with an adapter to measure e.g. dynamic contact angles with the needle method.

Automatic multiliquid dispenser (T314)

Automatic drop formation using up to 4 liquids simultaneously. Especially for automated surface free energy (SFE) measurements where more than two liquids are needed.

Related items

- Precision syringe without needle, 1 ml (C205)
- Precision syringe without needle, 1 ml, for C201 (C205A)
- Needle for C205 and C205A/C201, gauge 14 (C209-14)
- Needle for C205 and C205A/C201, gauge 22 (C209-22)
- Needle for C205 and C205A/C201, gauge 30 (C209-30)
- Hydrophobic needle for C205, C205A/C201, gauge 14, 20 pcs (C209A-14)
- Hydrophobic needle for C205, C205A/C201, gauge 22, 20 pcs (C209A-22)
- Hooked needle for C205 and C205A/C201, gauge 22 (C210-22)
- Hooked needle for C205 and C205A/C201, gauge 14 (C210-14)
- Hose tubing assembly for C201 autodispenser (KSP100008)
- Additional dispenser set for C201 with multiple liquids (C201-SET)
- C514HV-200, Disposable tips for high viscosity liquids for C311-300, 1000 pcs
- C514PP-200 Disposable polypropylene tips for C311-200 and C311-300, 1000 pcs
- C514PFA-100 Disposable PFA tips for C311-200 and C311-300, 96 pcs
- C514PC-200 Parylene coat tips for C311-200 and C311-300, 96 pcs
- C514PC-200 Parylene coat tips for C311-200 and C311-300, 96 pcs
- C514DCA, Needle adapter pack for C311-300, 2 pcs PTFE adapters and 50 pcs disposable gauge 30 needles
- C205B, Disposable syringe for manual dispensing, 50 pcs
- C209B-14, Disposable needle for C205B and C205, gauge 14, 50 pcs
- C209B-22, Disposable needle for C205B and C205, gauge 22, 50 pcs
- C209B-30, Disposable needle for C205B and C205, gauge 30, 50 pcs



Manual precision syringe dispenser (C205M)

Automatic single liquid dispenser (C201)

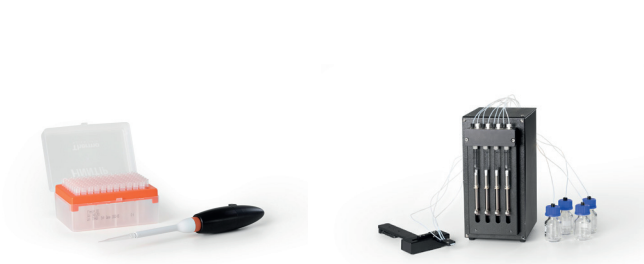

Automatic disposable tip dispenser (C311-300)

Automatic multiliquid dispenser (T314)

Dispenser Holders

Dispenser holder is responsible for depositing the droplet on the sample in a contact angle measurement.

Manual dispenser holder (T221)

Gentle drop deposition when automation isn't required. Simple one touch design gives high repeatability of the deposition.

Manual dispenser holder with manual rotation (T222)

For automated single or double disposable tip dispensing with manual gentle droplet deposition and manual dispenser rotation. When disposable tip dispensers C311-300 are used with manual deposition.

Automatic dispenser holder (T301)

Automatic drop placement on the sample. For more automated measurements with less user interference.

Automatic dispenser holder with automatic rotation (T302)

Automatic droplet placement on the sample, also using double disposable tip dispensing. Enables the use of two C311-300 dispensers with automated deposition.

Sample Stages

Sample stage holds the sample in a contact angle measurement. Attension offers stages from fully manual to fully automatic ones.

Manual sample stage (T310)

Precise manual movement of the stage in all three directions when automation isn't required.

Automatic X sample stage (T320)

Automated sample stage movement in x-direction enabling automated parallel measurements. Manual movement in y- and z-directions.

Automatic XYZ sample stage (T330)

Automated sample stage movement in all directions enabling automated parallel measurements and automated mapping of surface homogeneity.

Large sample stage top (T3X0L)

Large sample stage top to facilitate using bigger samples. Dimensions 120 mm x 120 mm. Compatible with any of the sample stages T310, T320 and T330. Readily included in Theta Flow.



Hooked needle for C205 and C205A/C201, gauge 22 (C210-22)



Needle adapter pack for C311-300 (C514DCA)



Manual dispenser holder (T221)



Manual dispenser holder with manual rotation (T222)



Automatic dispenser holder (T301)



Automatic dispenser holder with automatic rotation (T302)



Manual sample stage (T310)

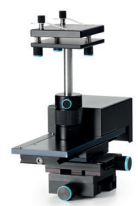

Automatic X sample stage (T320)



Automatic XYZ sample stage (T330)

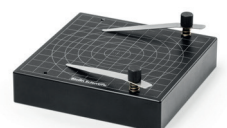

Large sample stage top (T3X0L)

3D Topography Module (T316)

The Attension 3D Topography module gives the roughness corrected contact angle of a surface automatically with a single click. In one measurement, both surface roughness and contact angle are measured automatically.

Related Items

3D Topography validation pack (T316A)

Surface topography validation pack with known structured microroughness pattern. Enables comparing measured and theoretical roughness value.

High Pressure Chamber (T317)

Wettability and other interfacial phenomena are important in many high pressure applications. For example in enhanced oil recovery, optimizing the wettability conditions under high pressures has a great effect on the efficiency of the oil recovery. The Attension High Pressure chamber enables optimal interfacial tension and contact angle measurements at high pressures and temperatures. Unique piston solution makes it possible to perform accurate measurements also with surfactants.

Related Items

Resistor temperature control for HPC (T317A)

Temperature control system from ambient to 200°C.

Peltier temperature control for HPC (T317B)

Temperature control system from 1 to 70 °C. Includes the peltier element and a Julabo water bath.

Manual pump for HPC (T317C)

Manual pump for pressurizing the chamber with liquids.

Automatic liquid pump for HPC (T317L)

Automatic Shimadzu liquid pump for pressurizing the chamber or creating a droplet of liquid.

Automatic liquid and gas pump for HPC (T317D)

Automatic ISCO pump for pressurizing the chamber with liquids or gasses.

Consumable pack for HPC (T317F)

Consumable kit including 15 full sets of Viton O-rings, 2 full sets of screws, 15 connectors, new torque wrench and Teflon tape.

Window set for HPC (T317K)

A window set including all three windows and related Viton O-rings. Advised to be changed at least every 12 months.

Temperature probe for HPC(T317J)

Spare PT-100 temperature measurement probe, one already included in the chamber package.

Eccentric needle for HPC, gauge 22 (T317M)

Eccentric needle for HPC, enabling placing multiple contact angle droplets with a single loading.

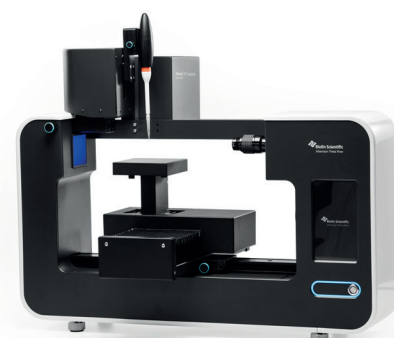

Attension Theta Flow with the 3D Topography module (T316)

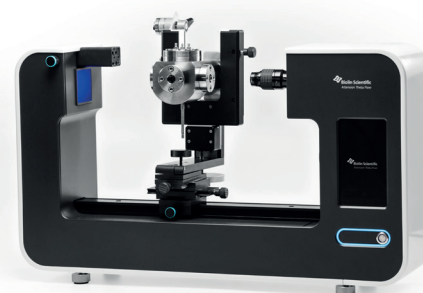

Attension Theta Flow with the High Pressure chamber (T317)

- Needle for HPC, gauge 14 (T317E-14)
- Needle for HPC, gauge 22 (T317G-22)
- Needle for HPC, gauge 30 (T317H-30)



Manual pump for HPC (T317C)



Automatic pump for HPC (T317D)



Automatic pump for HPC (T317L)

Pulsating drop module (T214)

Interfacial viscosity and elasticity have a prime importance in various applications. Interfacial elasticity can for example effectively predict the emulsion stability of a water-oil emulsion. The Pulsating drop module measures the interfacial dilatational viscosity and elasticity in an automated measurement. Both liquid-air and liquid-liquid interfaces can be measured with ease.

Related Items

Large cuvette also for high temperatures (C208A)

For measurement of interfacial tension between two liquids by pendant/raising drop method also at high temperature.

Hooked needle for C205 and C205A/C201, gauge 22 (C210-22)

Hooked needle for C205 and C205A/C201, gauge 14 (C210-14)

Tilting cradle (C204A)

Advancing and receding contact angles, often referred to as the dynamic contact angles, are commonly used as an indicator of the surface homogeneity. Tilting method is a common practice for measuring the dynamic contact angles. The tilting cradle can be used for automated measurement of the dynamic contact angles. The tilting cradle tilts the entire instrument, and advancing and receding contact angles are measured at the exact moment the droplet on the surface starts moving.

Related Items

Vacuum sample stage top (C204B)

A vacuum operated sample stage top, used to fix a substrate in place while tilting.

Vacuum pump (C204C)

Vacuum pump for the vacuum stage top.

Tilting stage (C218)

Tilting stage with manual tilting. Used for studying dynamic contact angles. Tilting range from 0 to 90°. Coarse and fine tilting movement.

Automatic picoliter dispenser (T315A)

Automated picoliter-scale drop formation. Especially for inkjet applications and for measuring contact angle on very small sample areas.

Related Items

Nozzle heater (T315B)

Additional nozzle heater enables wider viscosity range up to 100 mPas. Possibility to choose dispenser head with different nozzle sizes between 50 and 100um.

Convex sample holder (T315C)

A convex sample holder for film samples such as papers and polymer films.

Sample holder for horizontal single fiber (T315D)

Sample holder for single fibers to make picoliter drop placing easier. Adjustable length option for the fiber ranging from 25 mm to 75 mm.



Attension Theta Flex with the Pulsating drop module (T214)

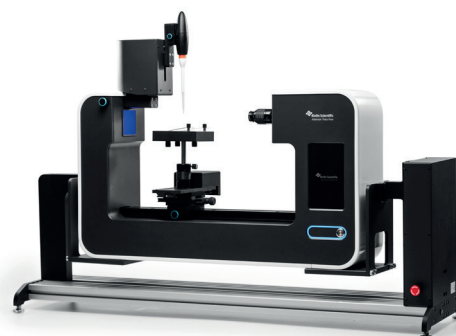

Theta Flow with the Tilting cradle (C204A)



Theta Flow with the Tilting stage (C218)



Theta Flow with the Automatic picoliter dispenser (T315A)

There is a large group of different environmental chambers available for every application. Temperature can be controlled using an electrical heater or water bath.

Measure chamber, room temperature (C202)

Room temperature measuring chamber for environmental protection (e.g. air flow) of substrate and drop.

Measuring chamber, electrically heated, 250° C (C203E)

Thermostatted electrically heated measuring chamber for air phase temperature control of substrate and drop.

Measuring chamber, fluid bath heated, 110° C (C203W)

Thermostatted fluid bath measuring chamber for air phase temperature control of substrate and drop. Requires fluid bath.

Liquid/liquid chamber, fluid bath heated, 100° C (C217W)

Thermostatted fluid bath liquid/liquid measuring chamber. Can be used for liquid/liquid contact angle studies. Requires fluid bath.

Temperature measurement probe (TCP)

Pt-100 temperature measurement probe.

PT-100 temperature probe for T102ME (T102MT)

PT-100 temperature probe to enable stand-alone temperature control by the T102ME in the sample vessel.

Bath/circulator, Julabo CD-200F (T102USB)

A constant temperature bath/circulator, for sample liquid temperature regulation. Attension software controlled, fully automatic operation or stand-alone. USB connection. Temperature range -20 to +150°C. Stability $\pm 0.03^\circ\text{C}$. Digital readout.

Bath/circulator, Julabo DD-300F (T102DD)

A constant temperature stand-alone or Attension software controlled bath/circulator for sample liquid temperature regulation. USB connection. Temperature range -25 to +200°C. Stability $\pm 0.01^\circ\text{C}$. 3.5" TFT Display.

Cabinet for Theta (CABI LARGE)

Transparent cabinet to protect the instrument from airborne particles and air currents. Openings for water inlets. Double doors at front for easy access to the instrument.

Active vibration isolation system small (AVS-LARGE)

Especially recommended to prevent influence of vibrations in sensitive pendant drop measurements. Active vibration isolation system includes two long isolation elements, external controller, bread board table and necessary mechanics.



Measuring chamber, room temperature (C202)



Measuring chamber, electrically heated (C203E)



Measuring chamber, fluid bath heated, 110° C (C203W)



Liquid/liquid chamber, fluid bath heated, 100° C (C217W)



Temperature measurement probe (TCP)

Large cuvette also for high temperatures (C208A)

For measurement of interfacial tension between two liquids by pendant/raising drop method also at high temperature.

Quartz cuvette, compatible with C208W (C208C)

1 optical quality quartz cuvette compatible with C208W.

Fluid bath heated cuvette chamber for interfacial tension studies with separate cuvette, 100°C (C208W)

For measurement of interfacial tension between two liquids by pendant/raising drop method. Includes cuvette C208C and water bath thermostatted sample stage cuvette holder. Requires water bath.

Calibration ball pack, with certificate (C216)

Calibration pack with certified calibration ball made to UKAS GB04/6133.00 including original certificate document.

Contact angle and surface tension verification pack (C216A)

Contact angle and surface tension calibration verification pack.

Comes with certification.

PC (C215)

Computer with pre-installed OneAttension software.

Sample scanner (T318)

QR-code / barcode scanner for automatically labeling experiments, loading measurement parameters and filtering the desired results.

Service

Attension offers a variety of different service options from service contracts to repairs. Please contact your local sales representative to find out more.

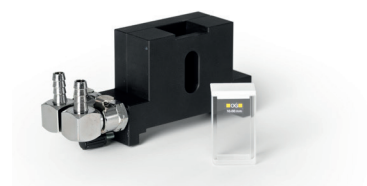

Fluid bath heated cuvette chamber (C208W)



Large cuvette for high temperature (C208A)



Calibration ball (C216)



Contact angle and surface calibration pack (C216A)



Try InstruMentor to find your optimal configuration

Our tool InstruMentor will guide you along the way to your new instrument. You can easily create your configuration based on what you would like to measure or what is suitable for your specific application area. You can also build an instrument from scratch based on all our frames and accessories. Get started at biolinscientific.com

About us

We are Biolin Scientific. A worldwide company making state of the art instruments and smart solutions for scientists. Knowledge is our greatest resource and an essential part of everything we do. In collaboration with leading universities and industries, we solve challenges to simplify the everyday life in the lab. Our customers are the experts in surface science, and we have the tools for them to progress.

Biolin Scientific AB | Hängpilsgatan 7, SE-426 77 Västra Frölunda
+46 31 769 7690 | info@biolinscientific.com | biolinscientific.com

