

DC Hall system with cryogenic probe station Model 8425



DC Hall system with cryogenic probe station Model 8425

Non-destructive Hall measurement of wafer-scale materials in a tightly controlled cryogenic environment

Advancing materials research

Featuring the latest in Lake Shore Hall measurement capabilities, the Model 8425 is ideal for a number of applied physics, electrical engineering, materials research, and product R&D applications. Measure electronic and magneto-transport properties of novel materials, including:

- Solar cells** OPVs, a:Si, μ c-Si, CdTe, CuInGaSe (CIGS)
- Organic electronics** OTFTs, Pentacene, Chalcogenides, OLEDs
- III-V semiconductors** InP, InSb, InAs, GaN, GaP, GaSb, AlN-based devices, high-electron mobility transistors (HEMTs), heterojunction bipolar transistors
- II-VI semiconductors** CdS, CdSe, ZnS, ZnSe, ZnTe, HgCdTe
- Elemental semiconductors** Ge, Si on insulator devices (SOI), SiC, doped diamond SiGe-based devices (HBTs and FETs)

High-temperature superconductors

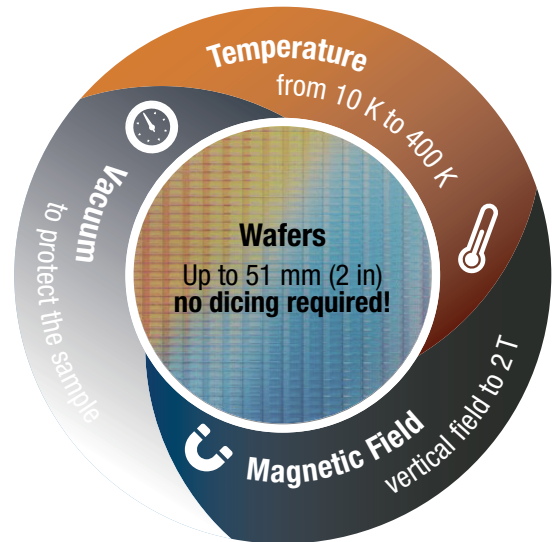

Direct and derived measurements as a function of field and temperature

- Hall voltage
- IV curve measurements
- Resistance
- Magnetoresistance
- Magnetotransport
- Hall coefficient
- Hall mobility
- Anomalous Hall effect (AHE)
- Carrier type/concentration/density

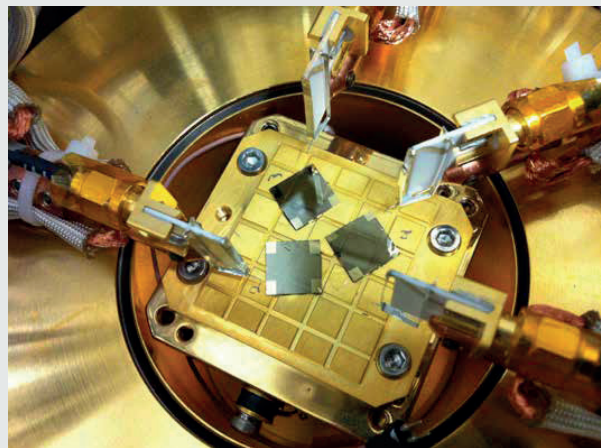
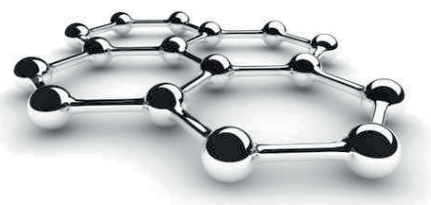
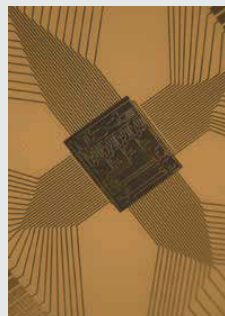

Non-destructive testing — no need to solder

The use of a probe station platform eliminates the need to attach wires to the sample (as required in a conventional Hall measurement system), speeding sample prep and avoiding any damage to the sample.



Sample soldering is not required

DC Hall system with cryogenic probe station Model 8425

- A complete Hall effect measurement system using device probing under vacuum in a probe station
- Supports a range of DC field Hall measurements—measure mobility on wafer-scale materials and structures as a function of temperature and field
- DC fields to 2 T and resistances from 0.5 m Ω to 100 G Ω
- Vary temperatures from 10 K to 400 K using closed-cycle refrigerator—no cryogen required
- Includes intuitive 8400 Series software for easy system operation, data acquisition, and analysis
- Supports exporting of data for multi-carrier analysis
- 3-year standard warranty



Two proven designs united

The Model 8425 combines the extensive Hall measurement capabilities of our 8400 Series HMS system with the flexibility and convenience of our CRX-VF cryogen-free probe station.

The ability to probe full or partial wafers up to 51 mm (2 in) in diameter eliminates dicing of fabricated wafers, as typically required in a conventional Hall measurement system. And because the sample is under vacuum (a function not available on standard Hall systems), it's an ideal measurement platform for materials susceptible to degradation caused by atmospheric exposure or that may require initial baking to drive out moisture.

Probing also offers the flexibility to measure more Hall structures and to use smaller devices. Repositionable probes eliminate the need for large fixed-wire contacts, and they enable multiple structures to be sampled on a wafer. Test structures can be as small as a millimeter in size.

Variable temperature and magnetic field measurements

The system provides the ability to make measurements from 10 K to 400 K, at maximum field of 2 T over the full temperature range in an automated fashion. (Manual adjustment of the probe station's heat switch is required at several temperature points.)

Generate direct and derived Hall voltage, Hall coefficient, Hall mobility, resistance, and IV curve measurements as a function of temperature. Varying temperature enables carriers to be identified by their excitation energies and provides clues to the dominating mechanisms in materials — insights that can yield important discoveries.

Highly sensitive device probing

The platform supports up to six ultra-stable probe arms for accurate tip placement (four arms are provided as standard). It offers true 90° wafer probing and includes our patented CVT (continuously variable temperature) probes that ensure consistent contact characteristics as measurements are made over wide temperature ranges. (For details on the probes, see page 8.)

The station also includes a vertical field superconducting magnet, a closed-cycle refrigerator (CCR) for cryogen-free operations, and a compact vacuum turbopump.

DC Hall system with cryogenic probe station Model 8425

Everything you need for making Hall measurements...

High-sensitivity imaging

7:1 zoom optics with a color CCD camera on a swing arm and a monitor (not shown).

Vacuum environment

ensures consistent measurement of materials that might be reactive to air.

Wafer-scale samples

on-wafer probing of material samples up to 51 mm (2 in) in diameter.

Precise probing

micro-manipulated probes with compliant tips for continuous measurement over a wide temperature range.

Vertical field magnet

Up to 2 T field when used for Hall effect measurements

Self-contained CCR

For convenient, automated cooling with no liquid cryogenics required.

Stable, heavy-duty stand

featuring passive vibration isolation and dampening

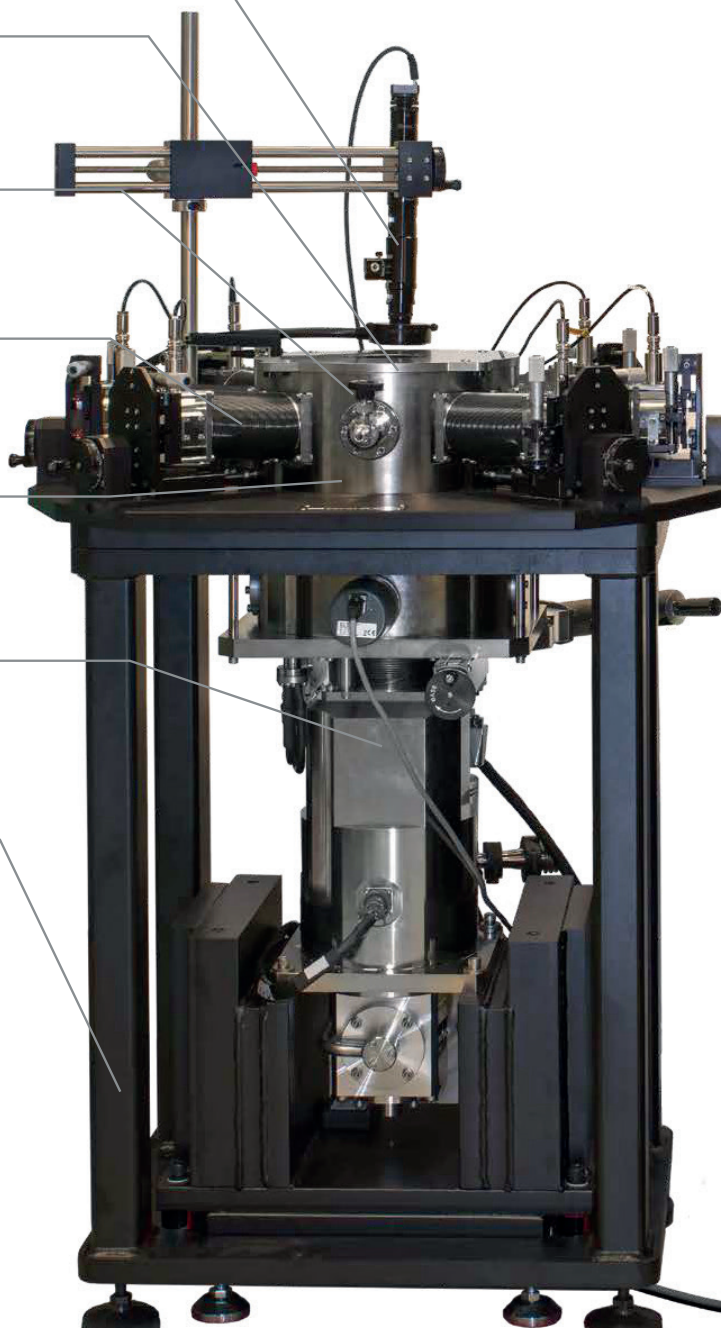

DC Hall system with cryogenic probe station Model 8425

...on full or partial wafers in a tightly controlled environment



Integrated system software —

Define samples, create measurement profiles, and run automated measurements from a menu-driven interface.

Centralized console —

houses all of the electronics and system control for convenient setup in a lab

Sources and meters —

includes a KI 6220 current source, a KI 2182A digital nanovoltmeter, and other optional instruments

Robust switch matrix —

Model 776 Hall effect switch matrix manages measurement signal switching and buffering.

Temperature instrumentation —

includes a Model 336 controller for precisely regulating sample stage and radiation shield temperatures, and for monitoring probe arm temperature.

Precision magnet power —

uses a Lake Shore 4-quadrant Model 625 superconducting magnet power supply for smooth continuous operation and low drift

DC Hall system with cryogenic probe station Model 8425

The characterization of the electronic transport properties of electronic materials is a very important activity. The bulk material characteristics of interest are resistivity, carrier density, and mobility. These properties are derived from film sheet resistivity and Hall voltage.

There are many methods for measuring sample sheet resistivity; most Hall measurement systems use either the van der Pauw or the Hall bar method. The Hall bar method uses one dimensional current flow approximation. Converting the resistance reading to resistivity requires knowledge of the physical size of the sample and the location of the contacts to the sample.

The van der Pauw method is specifically designed to measure arbitrary, two dimensional samples. The advantage of this method is that it is not necessary to know any physical dimensions of the sample. The van der Pauw equation is used to calculate the resistivity from a set of resistance measurements. This equation assumes that there are point contacts on the edge of the sample. Once the resistivity has been measured, the Hall voltage is measured. Then the mobility and carrier density can be determined from the Hall voltage and the resistivity.

The figure illustrates a long thin material of resistivity ρ . If a current, $I_x = nev_x$, is flowing in a sample of width w , length l , and thickness t_s , and a magnetic field B is applied perpendicular to the plane of the sample, the charge carriers will experience a Lorentz force. The Lorentz force will cause them to migrate along the trajectories shown in

the figure. Because no current can flow out of the sample in the y direction, the charges build up on the boundary. This establishes an electric field, and thus, a voltage V_H , which is called the Hall voltage. The Hall voltage V_H is proportional to the magnetic field B , current I_x , and Hall coefficient R_H , and the Hall voltage depends inversely on the sample thickness t_s . The Hall coefficient is $R_H = t_s V_H / I_x B = \rho_{xy} / B$ where ρ_{xy} is the transverse resistivity. The Hall coefficient and resistivity can be related to the carrier density n , the mobility μ , and the carrier charge e by:

$$\rho_{xx} = 1/ne\mu$$

$$R_H = 1/ne \quad \text{Hence,}$$

$$\mu = R_H/\rho_{xx} \quad \text{and} \quad V_H = R_H I_x B / t_s$$

Hall effect measurements with DC field

$$\rho_{xx} = \frac{V_x}{I_x} \frac{t_s w}{l} \quad R_H = \frac{t_s V_H}{I_x B} \frac{\rho_{xy}}{B}$$

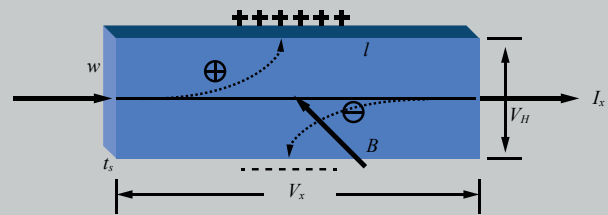

Advanced thermal control

All Lake Shore probe stations include unique thermal design features to ensure the highest possible confidence when recording sample temperatures.

The station's sample cooling assembly features a three-stage design, with isolation between the sample, radiation shield, and superconducting magnet. Each cryogenic stage is provided with a heater and sensor to offer quick thermal response and rapid warm-up for sample exchange. What's more, the sample chamber features thermal anchoring, and vapor-cooled shielding keeps blackbody radiation from reaching the sample.

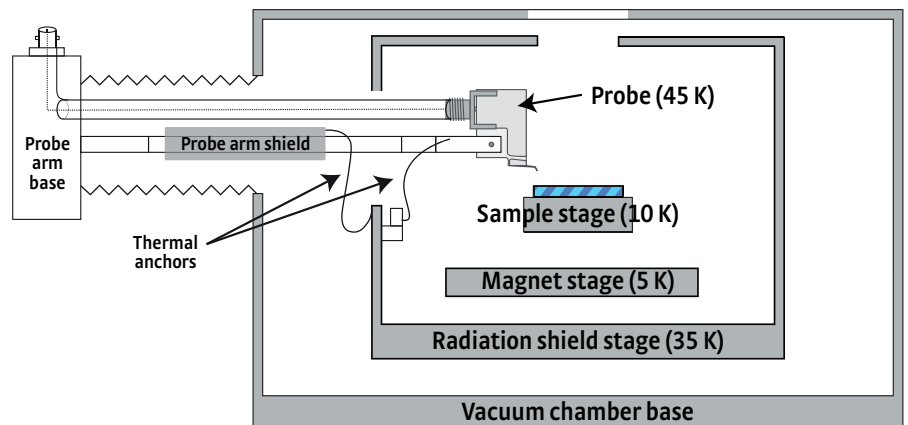

Probes are cooled to the sample stage temperature to minimize heat load to the device under test.

Plus the station includes a Model 336 temperature controller, which you use to accurately and precisely regulate sample stage and radiation shield temperatures while also monitoring probe arm temperature.

DC Hall system with cryogenic probe station Model 8425

Use the Model 8425 when developing new device designs

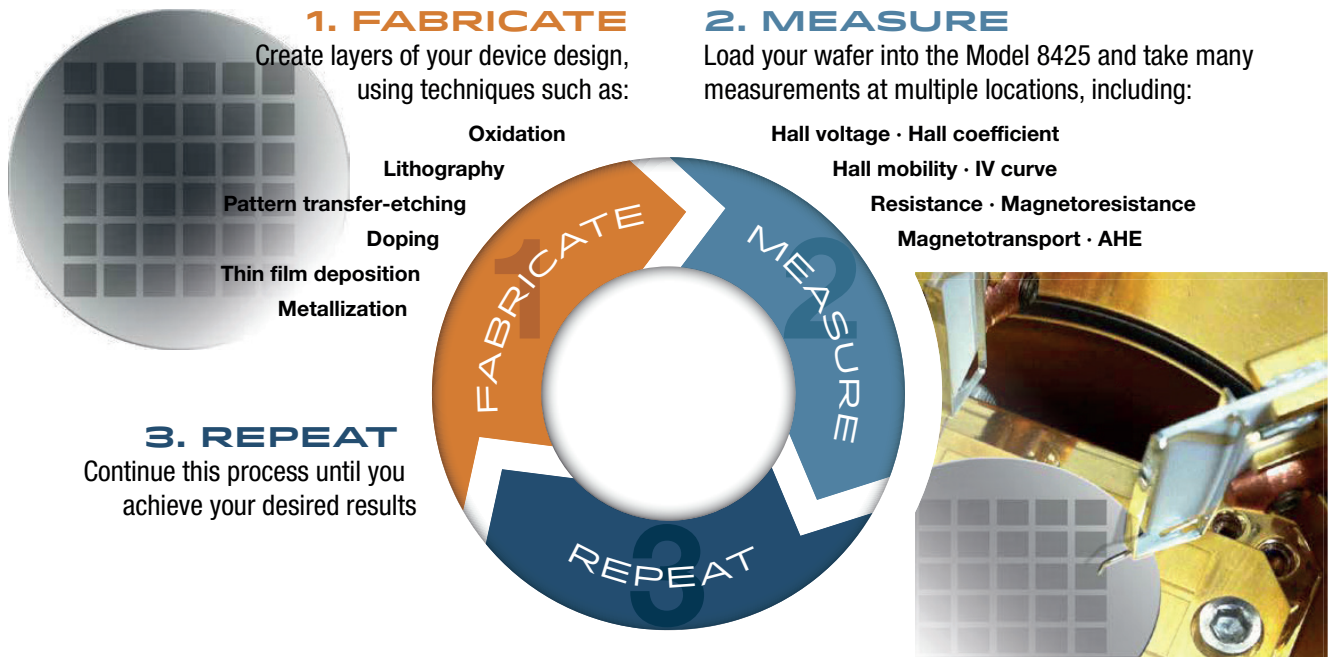

Model 336 temperature controller

Lake Shore flexible CVT probes, along with our Model 336 controller and Cernox™ sensors enable semiautomation of measurements



With probe arms thermally anchored to the sample stage, a standard probe tip may move as much as 400 μm as the stage warms from 4.2 K to room temperature. This prevents you from making automated variable temperature measurements, as probes have to be lifted and re-landed for any significant temperature transition.

Our patented CVT (continuously variable temperature) probe design absorbs arm movement caused by thermal expansion and contraction. The result is a highly stable probe tip landing position throughout variable temperature cycling, enabling continuous variable temperature measurements — which means faster and more automated experiments. You spend less time adjusting probe positions and more time conducting research.

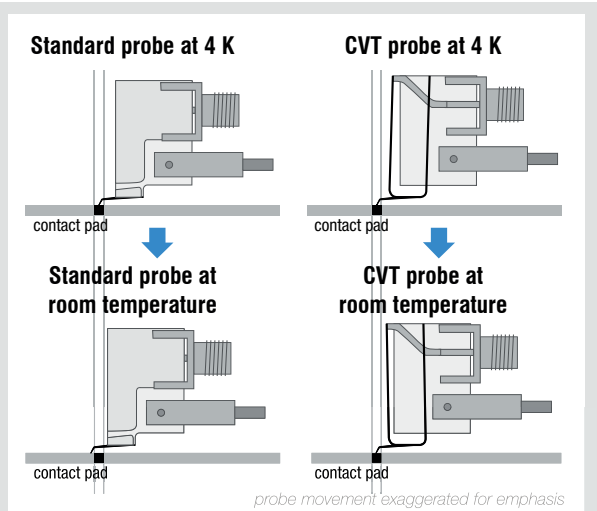

A comparison between standard probes and CVT probes. You can see that the standard probes would need to be repositioned before the arms expand enough to move them off the landing position. The CVT probes flex and maintain contact with the desired location.

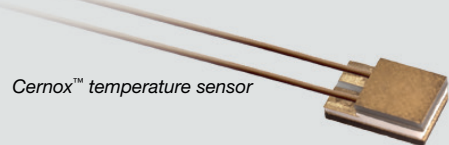

Cernox™ temperature sensor

DC Hall system with cryogenic probe station Model 8425

Software features

The fully integrated HMS software features a Windows® graphic menu-driven interface for system operation, data acquisition, and analysis. Use it to control magnetic field, sample temperature, and sample excitation while delivering a comprehensive collection of measurement capabilities. With the software, you have complete control over measurement parameters and can change them in real time.

Define and save specifications and experimental configurations as well as record and display data in laboratory and SI units for further analysis. Processed data can be displayed in graphical and tabular format. Also, with the software's SQL reporting capabilities, data and plots can be printed or exported directly to a Microsoft Excel® spreadsheet as well as PDF or Microsoft Word® documents.

Supports van der Pauw and Hall bar measurements

To measure sample sheet resistivity, the supports van der Pauw and Hall bar measurement geometries. The Hall bar method uses one dimensional current flow approximation. You can also measure samples with gated Hall bars to account for gate bias—important for measuring device-level material.

Measure Hall density in a channel as a function of gate voltage and, as you change the gate voltage, create more or fewer carriers. The system's program mode makes it easy to conduct gated Hall bar measurements. For instance, you can set up a loop with varying temperatures and gate voltages and easily perform a Hall measurement with the software.

Easy setup for running temperature loops

The system supports variable temperature measurements, enabling you to start and end at your convenience. It also enables you to perform time loops, so you can repeat Hall measurements according to a preset schedule. (Manual adjustment of the probe station's heat switch is required at several temperature points.) You can also program it to insert a resistance measurement into a sequence of Hall measurements.

Creating a new variable temperature Hall measurement can be done with just three clicks of a mouse. Once the measurement is set up, the software continuously monitors the sample temperature, and when it reaches the next trigger temperature, executes the measurements placed inside the temperature loop. While the measurements are in progress, the sample temperature continuously changes.

Commands enable you to “Go to Temperature,” “Go to Field,” and “Go to GBV” (gate bias voltage). You can also program it to “Wait,” that is, start a measurement then have the system pause and settle before continuing. This way, you have the flexibility to automate and customize your experiment procedure.



Hall measurement setup

Hall measurement setup is used to define the three basic steps in a Hall measurement. These steps include checking the quality of your sample contacts, measuring the resistivity of your sample, and measuring the Hall voltage.

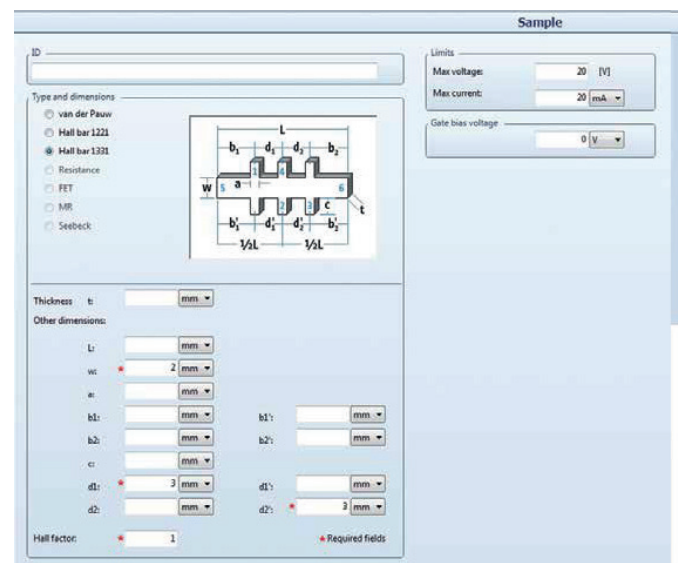

Define a sample

Define your sample geometry and contact arrangement, as well as the maximum voltage and current applied to your sample. Sample definition parameters include thickness and sample dimensions. You can assign sample identifications and add user comments. An ASTM compliance check can also be performed.

See larger software screen shots at lakeshore.com

DC Hall system with cryogenic probe station Model 8425

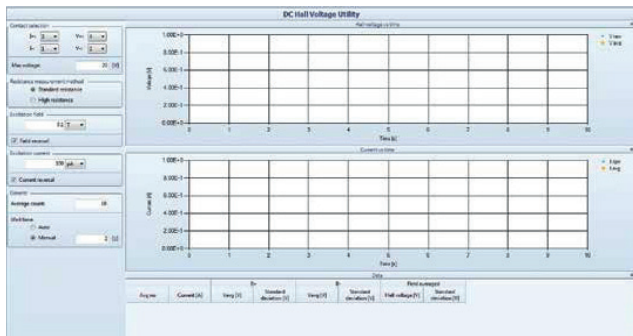

Software toolbox with resistance utility

The toolbox enables you to determine measurement parameters, log data, and display the data on screen as a chart recorder. You can also use it for resistance measurements at the start of an experiment. This is a very useful when you need to do a quick, initial check of a sample, to determine usable current, for instance. Once that's known, you can then proceed with experimentation to determine further integrity of the sample.

Can also be used with our optional QMSA software

The system can also be used with our Quantitative Mobility Spectrum Analysis (QMSA) software for advanced multi-carrier analysis. This software allows you to acquire detailed information about transport properties of the individual carriers, going beyond what's possible with single field Hall measurements. It's particularly useful for resolving individual carrier mobilities and densities in quantum wells and high electron mobility transistors.

8400 Series software capabilities

Sample types

- van der Pauw
- Hall bar 1221 and 1331

Direct measurements

- DC field Hall voltage
- Resistivity
- Ohmic check
- Four-wire resistance
- IV curves

Calculated measurements

- Hall coefficient
- Hall mobility
- Magneto-resistance
- Carrier type
- Carrier density

Field control

- Open-loop DC field control
- Closed-loop DC field control

Temperature control

- Closed-loop

User-defined programs

- Measurement loops for:
 - Variable temperature
 - Variable gate bias voltage
 - Time (repeatability)
 - Variable field
- Measurements for:
 - DC field Hall voltage
 - Resistivity
 - Ohmic check
 - Four-wire resistance
 - IV curves
- Environmental control for:
 - Go to temperature
 - Go to field
 - Go to gate bias voltage
 - Wait

Toolbox

- Chart recorder utilities
 - DC field voltage vs. time
 - Temperature vs. time
 - Four-wire resistance vs. time
- DC field calibrations (for open-loop field control)

Reports and exports

- Printing and exporting for Excel®, PDF, and Word®
- Export for QMSA®

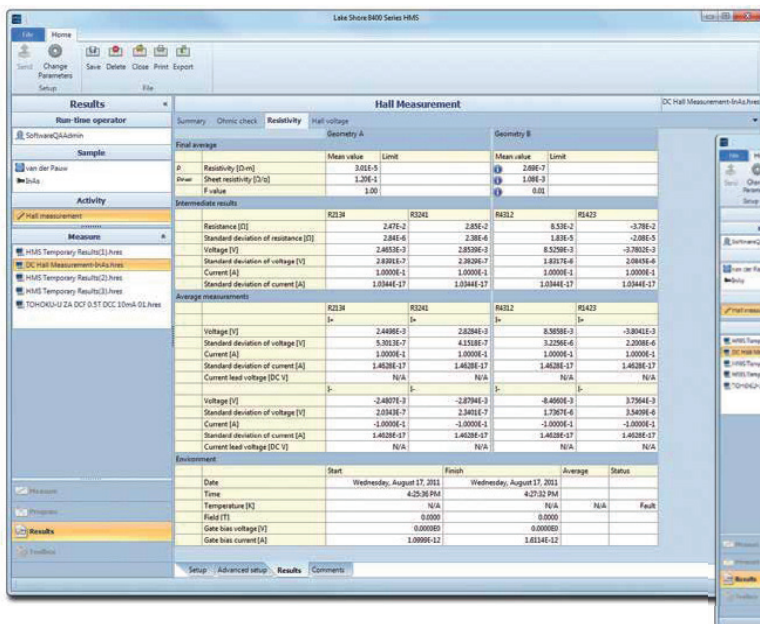

Example of a DC measurement results screen

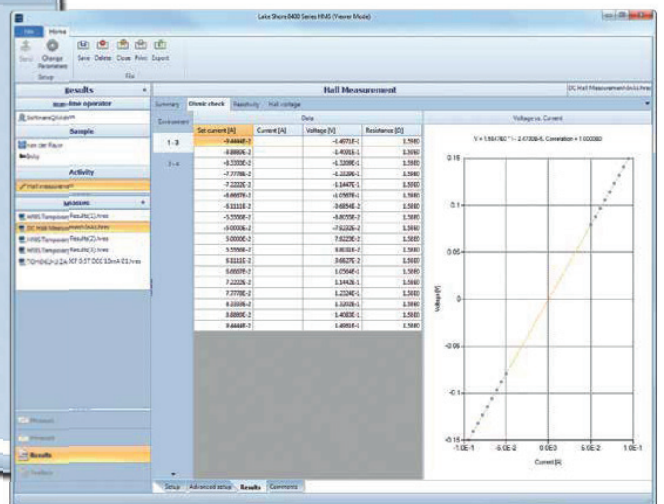

Example of an ohmic check

DC Hall system with cryogenic probe station Model 8425

Accessories and options

Extra probe arms for Hall bar measurements

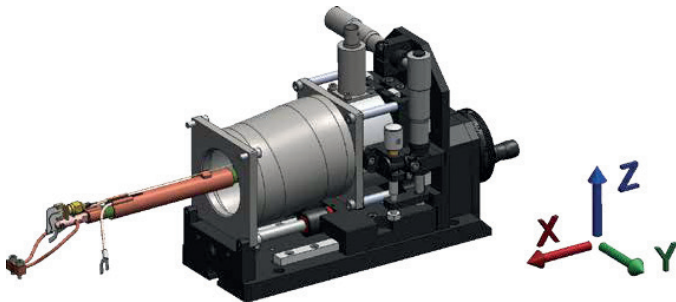

As standard, the Model 8425 system ships with four probe arms installed in the system for van der Pauw measurements. To also perform Hall bar measurements, the 84-HBM option provides two extra probe arms, probe arm cabling, and mounts.

PS-HV-8425 high-vacuum kit option

This option is for applications requiring even lower base pressures than what's possible with the vacuum system included in the standard Model 8425 probe station. With a vacuum to $<5 \times 10^{-7}$ Torr while the station is at base temperature, it represents an improvement of two orders of magnitude over the standard vacuum. It is recommended for samples highly sensitive to contamination or condensation during cooldown. And, with it, you can reduce pump-down time by about 30%.



PS-Z16 16:1 zoom optics vision system option

The vision system on the Model 8425 probe station features 7:1 zoom optics with a high-sensitivity, color CCD camera. The camera is specifically chosen for low light sensitivity to minimize the lighting required for high image quality. However, if you need greater magnification of a sample under test, an optional vision system is available to boost the camera's capabilities to 16:1 zoom optics. The lens fastens to the CCD camera shipped with the Model 8425 system.

84032P gate bias option

With this option, the gate bias voltage can be set to the user-determined value, increasing the flexibility of the Hall measurement. For instance, a gate voltage can be used to control the carrier density of a material. Option includes a Keithley Model 6487 picoammeter voltage source as well as a triaxial 51 mm (2 in) sample holder.

84031 high resistance option

Some materials are characterized by very high resistances and can be difficult to measure in a traditional Hall measurement system. These materials include semi-insulating GaAs as well as photo-detectors and solid state x-ray detectors. This option provides a resistance measurement range from 10 k Ω up to 100 G Ω . Includes a Keithley 6514 electrometer, buffers to minimize loading, and a signal lead guard to minimize the effect of current leakage.

DC Hall system with cryogenic probe station Model 8425

Model 8425 specifications

| Hall effect measurement capabilities | |
|---------------------------------------|--|
| Mobility | 1 to 1×10^6 cm ² /Vs |
| Carrier concentration density | 8×10^2 to 8×10^{23} cm ⁻³ |
| Resistivity | 1×10^{-5} to 1×10^5 Ω-cm |
| Standard resistance range | |
| ±0.5% rdg ±0.5% range | VdP/Hall bar minimum: 0.5 mΩ Maximum: 10 MΩ |
| ±0.075% rdg ±0.05% range | Maximum: 5 MΩ |
| Optional high resistance range | |
| ±0.25% rdg | VdP/Hall bar minimum: 10 kΩ Maximum: 50 GΩ |
| ±1.5% rdg | Maximum: 100 GΩ |
| Sample environment | |
| Cooling source | 2-stage closed cycle refrigerator (CCR) with 1 W cooling power at 4.2 K |
| Sample temperature | 10 K to 400 K |
| Sample sizes | Up to 51 mm (2 in) with SH-2.00-I (installed isolated sample holder) |
| Magnetic field | |
| Magnet type | Superconducting solenoid |
| Field orientation | Vertical (perpendicular to the sample plane) |
| Field capability | ±2 T for Hall measurement |
| Field homogeneity | 0.5% over 10 mm diameter; 1.0% over 25 mm diameter |
| Landed probe tip movement | <5 μm full field ramp |
| Measurements | |
| Station footprint | 800 mm (31.5 in) width × 670 mm (26.4 in) depth (does not include console or CCR compressor) |
| Console footprint | 766 mm (30.2 in) width × 754 mm (29.7 in) depth |
| CCR compressor footprint | 434 mm (17 in) width × 483 mm (19 in) depth |
| Utilities | |
| 1-phase voltage | 100/120/220/240 VAC (+5%, -10%), 50/60 Hz |
| 1-phase power | 3.3 kVA recommended |
| 3-phase voltage (CCR) | 200 VAC (50/60 Hz) or 380/400/415 VAC 50 Hz or 480 VAC 60 Hz |
| 3-phase power (CCR) | 6.6 to 6.9 kW at 50 Hz/7.5 to 7.8 kW at 60 Hz |
| Cooling water power | |
| Dissipation (CCR) | 8.5 kW max; 6.9 kW steady state at 50 Hz; 9.0 kW max; 7.8 kW steady state at 60 Hz |

*Probe contact resistance may vary with sample

| | |
|-----------------|---------------------------|
| Approval | All instruments CE marked |
|-----------------|---------------------------|

NOTE: For more CRX-VF probe station specifications, see www.lakeshore.com.

Ordering information

Model 8425 DC Hall system with cryogenic probe station

| Part number | Description |
|-------------|--|
| 8425 | Measurement console including: PC with 8400 Series HMS software, Model 336 temperature controller with 3062 scanner, Model 625 superconducting power supply, Model 776 switch matrix, Model 142 power amplifier, Keithley Model 6220 current source, Keithley Model 2182A voltmeter; Model CRX-VF probe station including: (4) probe arms (MMS-09) for van der Pauw measurements with cabling (ZN50C-T) and probe mounts (ZN50-55i); (12) CVT probes (ZN50R-CVT-25-W); isolated 51 mm (2 in) sample holder (SH-2.00-I, installed), grounded 32 mm (1.25 in) sample holder (SH-1.25-G); turbo vacuum pumping system (TPS-FRG and PS-TP-KIT); 7:1 zoom microscope system and monitor NOTE: must specify single phase (100, 120, 220 CE, 240 CE VAC) and 3-phase (200 VAC at 50/60 Hz, 380/400/415 VAC at 50 Hz, or 480 VAC at 60 Hz) line voltage at time of order |

Model 8425 options and accessories

| Part number | Description |
|----------------------------------|---|
| Measurement options | |
| 84-HBM | Hall bar measurement; 6 total probe arms are required for Hall bar measurement; option provides 2 additional MMS-09 probe arms, each with ZN50C-T cabling and ZN50-55i probe mount; software is already enabled |
| 84032P | Gate bias voltage measurement, factory installed: includes Keithley Model 6487 voltage source and 51 mm (2 in) triaxial sample holder (SH-2.00-T-VF) |
| 84031 | High resistance measurement; includes software, electrometer/ammeter, cables, and rack mount kit |
| PS-HV-8425 | High vacuum option for Model 8425. Ensures condensation does not accumulate in the sample environment during cooldown, which is critical for measuring organic semiconductors and for high Z and low current applications. Replaces standard turbo pump, includes HVAC port, V301 turbo pump kit, related HVAC components, and full range vacuum gauge. (Consult Lake Shore for field upgrade.) |
| PS-Z16 | High resolution microscope upgrade, factory installed (consult Lake Shore for field upgrade). Upgrades standard 7:1 zoom to 16:1 zoom optics with 4 μm resolution |
| Also available: | Optical excitation with topside illumination of sample using UV/IR; some restrictions apply; consult Lake Shore for details |
| Probe station accessories | |
| ZN50R-CVT-25-W | Additional probe, 25 μm tip radius, tungsten NOTE: 12 of these probes are included with the system |
| ZN50R-CVT-10-W | Additional probe, 10 μm tip radius, tungsten |
| ZN50R-CVT-25-BECU | Additional probe, 25 μm tip radius, beryllium copper |

Recirculating chillers

Contact Lake Shore for the current list of recirculating chillers

DC Hall system with cryogenic probe station Model 8425

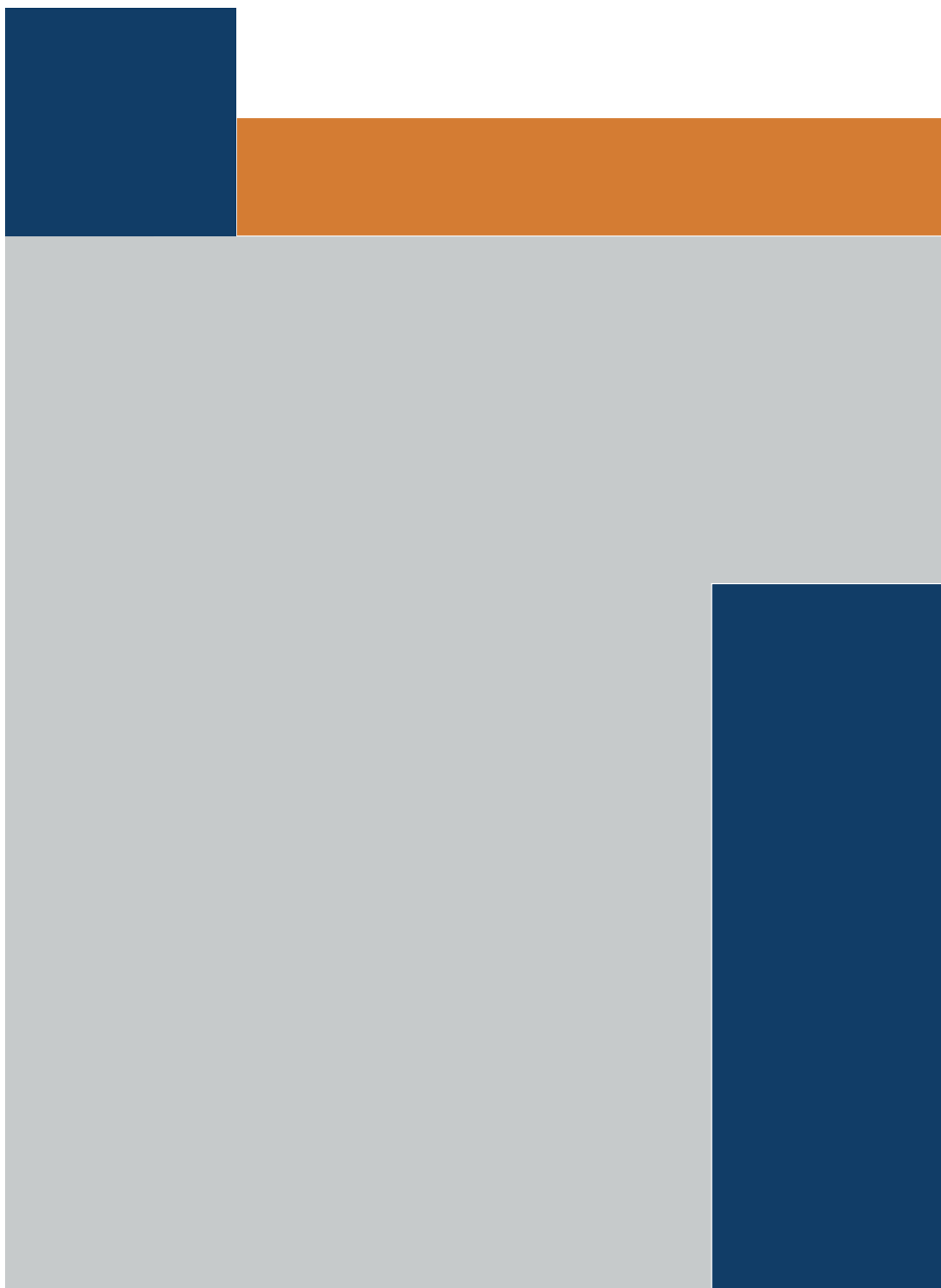

©2015 Lake Shore Cryotronics, Inc. All rights reserved.

*The technical and pricing information contained herein
is subject to change at any time. 080615*